

# Adaptive Network Based Fuzzy Inference System Model for Minimizing Handover Failure in Mobile Networks

Abidemi M. Orimogunje,  
Department of Electrical & Information Engineering,  
Covenant University,  
Ota Ogun State, Nigeria.  
abidemi.orimogunje@covenantuniversity.edu.ng

Olumide O. Ajayi  
Department of Electrical & Electronic Engineering,  
Adeleke University,  
Ede, Osun State.  
ajayi.olumide@adelekeuniversity.edu.ng

Olaosebikan A. Fakolujo  
Department of Electrical & Electronic Engineering,  
University of Ibadan,  
Ibadan Oyo State, Nigeria.  
olaosebikanfakolujo@gmail.com

Jeremiah O. Abolade  
Department of Electrical & Information Engineering,  
Covenant University,  
Ota Ogun State, Nigeria.  
jeremiah.abolade@covenantuniversity.edu.ng

**Abstract-** For seamless connection between mobile users on the same and different mobile technologies there is need for the deployment of a more complex algorithm for a successful switching of mobile users. Signal to interference ratio, speed of the mobile users and traffic distance are the three input used in the Adaptive network based Fuzzy inference system (ANFIS) which is an hybrid of two techniques of artificial intelligence which make it suitable to handle complexities such as ping-pong effect and interference which impair on the quality of service (QoS) during call handover process as the mobile users move from one coverage area (cell) to another.

**Keywords-** Seamless; Mobile; Signal to Interference Ratio; Adaptive Network Based Fuzzy Inference System; Ping-Pong; Cell; Quality of Service; Artificial Intelligence.

## I. INTRODUCTION

Among the advantages of mobile wireless communication is the ability to change position while using the mobile terminal i.e. a user with a mobile terminal could move within different cell domain and still enjoy communication link with other users on the network as illustrated in Fig.1.

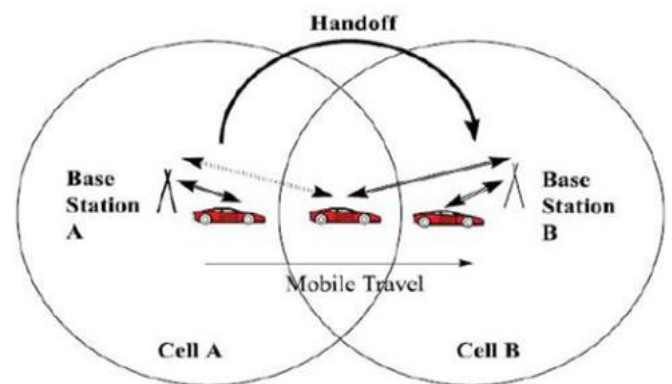

Fig.1. Handover Process Illustration [1]

The continuous communication of mobile users moving from one coverage area of the mobile wireless network to another coverage area of the network is made possible by handover process, also called Hand off process [2]. Handover involve change in frequency of connection of a mobile user on a mobile network from one node to another as the user move within coverage area of the mobile network connection [3][4].

To enjoy a good quality of service during handover process, a good handover algorithm is needed. The handover decision

algorithms prevent unnecessary handover, minimize handover delay, reduce system interference level by maintaining desired cell-boundaries and improve call quality during handover process in wireless networks [5].

## II. HANDOVER PROCESS AND DIFFERENT MOBILE GENERATIONS

### A. *The First Generation (1G) Of Mobile Wireless Network*

This generation of wireless mobile technology is referred to as “1G” and it was the era of analog cell phones. Most notably in this era was the advanced mobile phone systems (AMPS) used in U.S.A, Nordic Mobile Telephone (NMT), Total Access Communications System (TACS) [6]. The transmission from the base station to the mobile station (downlink) uses the range of frequencies between 869-894 MHz, while the transmissions from mobile terminals to the base stations (uplink) uses 824-849 MHz range of frequencies [7]. Though this generation of mobile networks has the advantage of long distance communication, it has several challenges which overshadowed among these are; a high call handover failure rate, poor quality of the voice signal, high call drop and interference [8]. The technique used to handle the call traffic in the first generation was the frequency division multiple access (FDMA) [9].

### B. *Second Generation (2G) of Mobile Wireless Network*

This was the generation of digital access technology in mobile networks and tagged “2G”. It uses technologies such as code division multiple access (CDMA), time division multiple access (TDMA) for Global System of Mobile communication (GSM) [9]. The 2G incorporates the use of short messages services (SMS), picture messages and multimedia services (MMS) into mobile technology [9]. The general packet radio services (GPRS) and enhanced data rate for GSM evolution (EDGE) technology are also used during the period (i.e. 2.5G) to enhance communication and to interfaces packet switching protocols into GSM networks. This generation operates within the frequency range of 900MHz and 1.8 GHz [7]. Data transmission is supported by 2G systems but at a slow speed of 9.6Kb/s and 14.4Kb/s when compared to the 5.8 Mb/s and 14.8Mb/s of 3G networks, therefore voice is given priority over data in 2G networks [7].

### C. *Third Generation (3G) of Mobile Wireless Network*

The third generation; “3G” technologies are founded on the standards set by International Telecommunication Union (ITU) family under the International Mobile Telecommunications program, IMT-2000. This generation covers 3G, 3.5G and 3.75G. The technologies of this generation provide mobile network users with a wide range of

advanced services and high bandwidth as well as the ability to roam around the globe [8]. The services provided by the 3G networks include wide coverage of wireless voice telephony, video calls, and broadband wireless data within a mobile environment [10]. 3G has the advantage of high speed packet access (HSPA) data transmission capabilities which is able to provide downlink speed of 14.4Mbit/s and an uplink speed of 5.8Mbit/s [10]. 3G is a universal mobile telecommunications systems (UMTS) evolution and uses a technology known as wideband code division multiple access (W-CDMA). Also it supports the following technologies CDMA, TDMA and FDMA [10].

### D. *Fourth Generation (4G) Of Mobile Wireless Network*

This technology is for high-speed mobile wireless communications designed to handle new data services and interactive TV communication through mobile network. 4G mobile wireless technologies started in 2010 [7]. Security is one of the challenges that is being handled by this generation of mobile technology and it include upgrades such as the provision of internet protocol (IP) features, orthogonal frequency division multiple access (OFDMA) technology and a download rate of 100Mbps [9]. The International Telecommunication Union (ITU) labeled the 4G mobile technology as IMT-Advanced (International Mobile telecommunication Advanced) [9]. The three major focus of the 4G mobile technology are; Ubiquity, Multi-service platform, Low bit cost [11]. “Third Generation Partnership Project (3GPP) has already planned for a work item called LTE-Advanced to meet the IMT-Advanced requirements for 4G” [7].

### E. *Fifth Generation (5G) of Mobile Wireless Networks*

The fifth generation of mobile network is still work in progress which should be deployed in year 2020 [12]. Through this generation, mobile internet and worldwide phone is expected to be accessible to everyone and come with a very high value technology. 5G networks will offer fast speed in gigabits for users, it will enhance quick handover of calls, support internet of things (IoT) and device to device (D2D) communications [13]. According to [12] about 0.5% of the total energy in the world is used by mobile networks and 5G is energy efficient and will reduce the energy consumed by the mobile equipments and networks. 5G networks uses Beam Division Multiple Access (BDMA) and Non and quasi-orthogonal or filter Bank multi carrier (FBMC) multiple access, it consist of two logical layers; a radio network and a network cloud [14]. Also, this generation will address the following challenges; higher capacity, higher data rate, lower end to end latency, massive device connectivity, reduced cost, and consistent quality of experience provisioning [14].

### III. HANDOVER PROCESS AND ITS CATEGORIES

The handover process is broadly classified into: Hard handover, soft handover, downward, upward, horizontal handover and vertical handover.

#### A. Horizontal Handover

This is the type of handover process that occurs between mobile network systems of the same technology. Figure below shows the diagram of different types of horizontal handover process. Most of the horizontal handover algorithms developed to execute horizontal handover process uses received signal strength as the only parameter for making the handover decision [15]. Horizontal handover is further divided into four different types; intra BTS, inter BTS/intra BSC, inter BSC/ intra MSC and inter MSC handover.

- i. Intra BTS Handover: This is the type of handover process experienced by mobile stations operating within the coverage area of the same Base Transceiver Station (BTS).
- ii. Inter BTS/Intra BSC Handover: This type of handover occurs between mobile users operating within coverage

area of two or more different base transceiver station attached to the same base station controller (BSC).

- iii. Inter BSC/Intra MSC Handover: The Handover between mobile network users operating under different base transceiver station (BSC) connected to the same mobile switching center (MSC) is called Inter BSC or Intra MSC
- iv. Inter MSC Handover: This is the Handover of on-going calls to the mobile stations operating under different Mobile Switching Center (MSC).

#### B. Vertical Handover

This is the changing of nodes of mobile users operating under different network technologies i.e. heterogeneous networks [16][17]. The development of the algorithm to implement the vertical handover decision is more complex compared to the horizontal handover because of the diverse features of the networks involved in the process[3]. The interplay between the various mobile network technologies requires vertical handover process for continuous communication of the mobile users. To ensure this, an algorithm that is more complex than the traditional handover decision algorithm and that incorporates different network and radio parameters is developed.

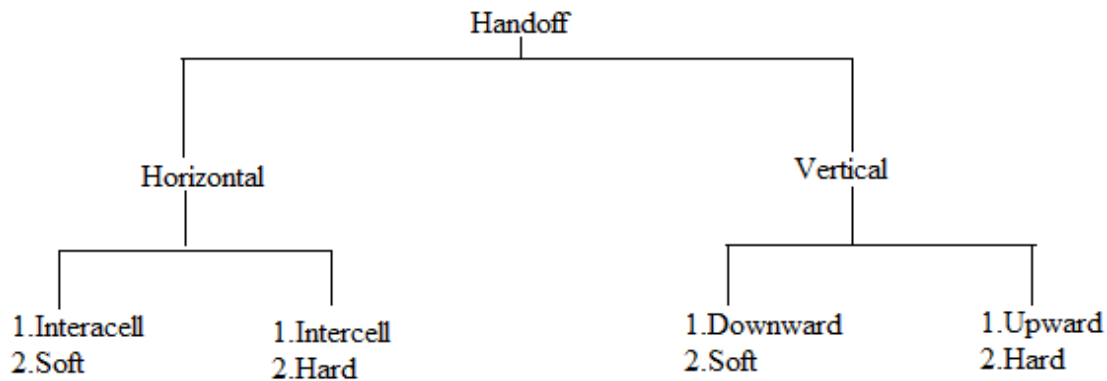

Fig.2. Types of Handover Process [18]

#### C. Upward and Downward Handover

The upward handover is a term used in vertical handover to refer to the changing of point of attachment of a mobile node (MN) from a small coverage area to a larger coverage area with a low bandwidth while the downward handover refer to the switching of a mobile node from a network with a larger area to a smaller area of a higher bandwidth [16][19].

#### D. Hard Handover

This is generally known as “break before make” meaning a mobile user is permitted to access only one channel at a time and has to be temporarily disconnected to establish connection using different communication channel.[20]. Hard handover is used in mobile technologies like OFDMA (Orthogonal Frequency Division Multiple Access), TDMA (Time Division Multiple Access) where different bandwidth are used in

adjacent channels to reduce interference between the frequency channels [2].

#### E. Soft Handover

This is referred to as “make before break” meaning a connection is established with other base stations as the mobile station moves from one place to the other during communication before terminating the connection with the present base station [2]. Soft Handover occurs in CDMA (Code Division Multiple Access)

### IV. PHASES OF VERTICAL HANDOVER PROCESS

For seamless connection of mobile users there are three stages which the handover process must undergo for successful interactions between heterogeneous technologies, they are: System discovery, Handover decision, and Handover execution.

- *System or Network Discovery Phase:* This is the phase where information on the parameters of networks are collected and compared before the system determine which network is the best to handover the call to. This phase is also referred to as Measurement phase or stage. Some of the parameters considered in this phase are received signal strength (RSS), Bandwidth, Cost of service, Speed or velocity of the mobile, power consumption [15].
- *Handover Decision:* This stage comes after the measurement stage and it is the stage where decision is made on which mobile network to handover the call to. At this stage different parameters are accessed and a decision to switch the point of attachment from the current network to the best network is reached after considering the parameters of different networks.
- *Handover Execution:* This is the stage where the actual handover process is carried out and at which the mobile node switches from the old network connection to the best network without affecting the communication between the mobile users. Authentication and authorization of mobile stations also takes place at this stage [21]

### V. NEED FOR HANDOVER

The depreciation in radio and network parameters of the base stations indicates a need for handover [22]. Some of these factors are: the received signal quality, the received signal strength, distance of mobile station from base transceiver station (BTS) and a drop below link budget [23]. The handover process is initiated if the following radio parameters are affected in the following ways; if the received signal

quality is too low or the bit error is too high, if the signal strength is too low, the distance between the mobile stations (MS) and base station (BS), and then power budget. Handover can also be triggered if there is traffic congestion of call in the serving cell or channel [22]

### VI. HANDOVER STRATEGIES

There are three strategies used to detect the need for handover and execute the handover process, they are: Mobile controlled handover (MCHO), Network controlled handover (NCHO), Mobile assisted handover (MAHO) [2].

- *Mobile Controlled Handover:* In this strategy, the mobile equipment monitors the signal strength and the quality of signal from different base stations within its coverage area. The handover is initiated by the mobile equipment after analyzing the parameters of the network from the base station like proximity, interference etc. before initiating the process of handover.
- *Network Controlled Handover:* The different base stations (BS) monitors and measures the signals from the mobile equipment and the network (through the mobile switching center) initiates the handover based on the quality and strength of the signals from the mobile equipment. This method was used in the first generation of cellular systems such as advanced mobile phone system (AMPS) and total access telephone system (TACS).
- *Mobile Assisted Handover:* This involves interchange of responsibilities between the mobile station and the network to monitor as well as measure the signals before handover process occur. While both the mobile station and base station oversees the quality of the received signal and the network request, the mobile station specializes in the measurement of received signal strength indication (RSSI) from the base stations in the surroundings after which the result is transmitted to the base station twice within a second for assessment before making handover decision [2].

### VII. INDICES FOR HANDOVER PROCESS

The parameters which influence handover process are discussed below:

- *Received Signal Strength:* This parameter is extremely important in determining handover process as it determines the quality of service experienced by the mobile users [15]. Most of the traditional handover decision algorithm uses this parameter to determine handover between homogeneous networks [17]. There are three groups of handover algorithm using received signal strength (RSS); the first group uses RSS only and the

handover decision are made after analyzing the RSS of the current base station and the neighboring base station (BS). In this group, handover occur only when the RSS of the neighboring base station is higher than that of the current base station and this could lead to back and forth handing over of the call between the two or more base stations involved as a result of fluctuations in the signal strengths of the base stations and the fluctuations is called ping-pong effect [5].

- *Bandwidth:* The higher the bandwidth the lower the number of call drop and the call block [3][19]. “Bandwidth is the rate of data over a specific network connection or interface during a period of time”[17]. This parameter must be well managed for effective handover because it expresses the traffic situation of a network in bits per seconds. It is also known as link capacity [17].
- *Velocity:* This is the rate at which the mobile user is changing position during the period of communication. The speed (velocity) of the mobile is an important parameter in handover process especially between networks of different access technology [3]. The speed (Velocity) at which the transition of the mobile user affects the handover initiation.
- *Power Consumption:* To conserve power usage of the mobile equipment especially when the battery is low, the call is handover to the nearest base station and to a network with low power consumption [17].
- *User’s preference:* The service quality and service type (voice, data or video) depend on the preferred network of a mobile user [18]
- *Monetary Cost of Service:* There are different policies for billing services of various mobile network providers and this factor impact the decision of the mobile user to either switch from one network to another or continue with its original network after considering the rate for new call arrival and handover call based on the cost function [15].
- *Network Security:* Integrity and privacy of some applications are critical factor in handover decision. “The strength of mobile networks lies in its ability to monitor and protect against intruders (unauthorized access), hackers, software virus that may compromise integrity and privacy of customer’s information within a network” [3]
- *Network Traffic:* Network Load balancing in the adjacent cells improve the quality of service, simplify the cell planning and channel assignment, remove the need for

channel borrowing and minimize the number of call block [17]

- *Throughput:* This is the mean of successful data or message delivery over a specific communication link.
- *Handover latency:* Latency can cause number of call drop to increase and effective handover algorithm minimize the effect of handover latency so as to improve the quality of service [3].

### VIII. ADAPTIVE NETWORK BASED FUZZY INFERENCE SYSTEM (ANFIS)

Adaptive network based fuzzy inference system is also referred to as Adaptive neuro-fuzzy inference system [24]. ANFIS is an hybrid system which combine fuzzy logic system (FLS) and artificial neural network (ANN) techniques by optimizing the strength of both methods of artificial intelligence and then minimize the shortcomings of the methods to obtain an adaptive system which has better result and intelligence compared with each of the method separately[25]. Due to unpredictability of factors responsible for handover process in mobile networks and irregularity nature of these factors, ANFIS method are being used to study the changes in the pattern of these parameters over a period of time and then train the network to make handover decision based on the pattern of changes observed during the training of the data. ANFIS is an adaptive network of artificial neural network and fuzzy inference system combining the ability of the neural network to supervise learning and it works on existing input and output data to generate fuzzy membership rules[26].

#### A. Artificial Neural Networks (ANN)

Artificial neural network is a way of processing information just like the human nervous system processes information [27]. The network is a link of neurons which are working together to solve a particular problem. The artificial neural network operates in a way that is close to how information is being processed by the nervous systems (neurons) in human brain.

The component of the nervous system which has the ability for information processing is the neuron and the similarities between the neurons and the artificial neural network are:

- The dendrites in neuron which is similar to the input in artificial neural network
- The cell body which is similar to network structure
- The axon which is similar to the output of the artificial neural network

Artificial neural networks has neurons as the computational units, add different inputs weighted and after applying certain activation function on the addition of the inputs then the

resulting value is the output of the neuron [27]. A weight is a number assigned to the connection between two neurons [28].

**B. Training Artificial Neural Network**

Training data is needed to adjust the weight of the network connections. One of the ways of training artificial neural network is by supplying the network with learning pattern and then allows it to change its way according to some learning rule [27]. The two categories of learning available are supervised learning which is also known as associative learning and unsupervised learning which is also known as self-organization. In supervised learning the input and corresponding output is used in training the network and in unsupervised learning the output unit is trained to collection of pattern within the input [27].

**C. Fuzzy Inference System (FIS)**

Fuzzy inference system uses fuzzy set theory, fuzzy if then rules and fuzzy reasoning. Figure 3.3 below show the

processes involved in Fuzzy inference system. The fuzzy inference system model consists of the following fundamental components:

- a rule base which consist of fuzzy rules,
- a database that defines membership functions of the fuzzy rules
- a decision making unit which work on the fuzzy rules
- a fuzzification interface which transforms the crisp input into fuzzy set
- a defuzzification interface which transforms the result of fuzzy set back into crisp output [24]

Fuzzy inference system is built on “fuzzy-if-then rule” concepts. Fuzzy-if-then rules are linguistic variables using the statement If X then Y where X and Y represent the fuzzy set characterized by membership function[24]. The fuzzy if-then rules are used to capture the imprecision and uncertainty that exists in human reasoning when decision are to be made[24].

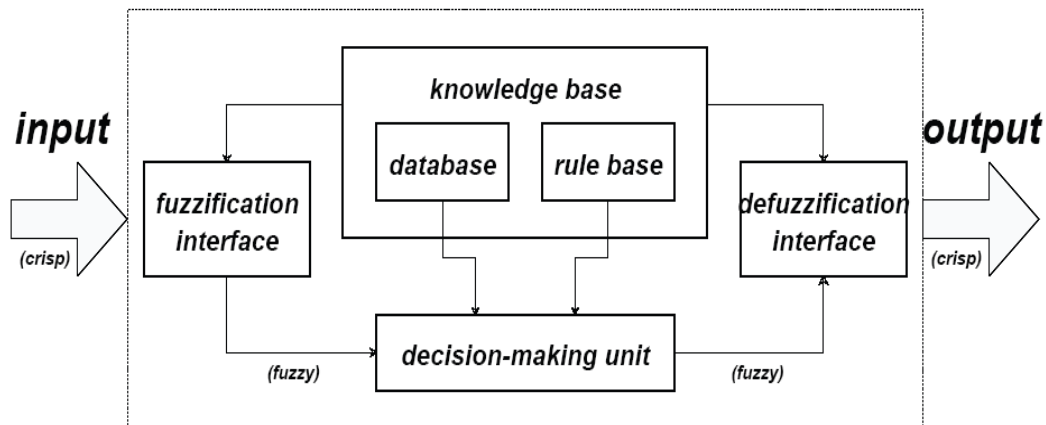

Fig.3. Fuzzy inference system [28]

The Fuzzy Inference System is applicable in various fields like data classification, automatic control, expert system, decision making, robotics, time series analysis, pattern classification, system identification etc[29].

Mamdani and Sugeno Fuzzy inference system are basically the two types of fuzzy inference techniques. Mamdani method entails computational burden though it captures expert knowledge in more intuitive and human-like manner[27] on the other hand, the Sugeno method is effective for handling computations and it is used for optimization and adaptive models especially in nonlinear system[30].

The basic difference between Mamdani-type FIS and Sugeno-type FIS is the manner in which the crisp output is produced

from the fuzzy inputs. While Mamdani-type FIS uses the method of defuzzification of a fuzzy output, Sugeno-type FIS uses weighted average to calculate the crisp output. The processing time is another major difference between the two FIS methods, the Sugeno has better processing time compared to the Mamdani method since the weighted average replace the time consuming defuzzification process that exist in Mamdani method. Mamdani-type FIS is mostly used in decision support application because of interpretability and intuitiveness of the rule base. Other differences are that Mamdani FIS has output membership functions whereas Sugeno FIS has no output membership functions. Mamdani FIS is not as flexible and adaptive for system design compared with Sugeno FIS which can be integrated with ANFIS tool to enhance the outputs [30].

**D. Layers of ANFIS Structure**

The Fig. 4 shows the three input structure of ANFIS model developed for minimizing the handover failure in mobile networks. The ANFIS model consists of five different layers

namely; fuzzification layer, rule layer, normalization layer, the defuzzification layer and the single summation node [31].

The three input signals to the ANFIS models are; Signal to interference ratio (SIR), Traffic difference (TR) and Speed of the mobile (VEL).

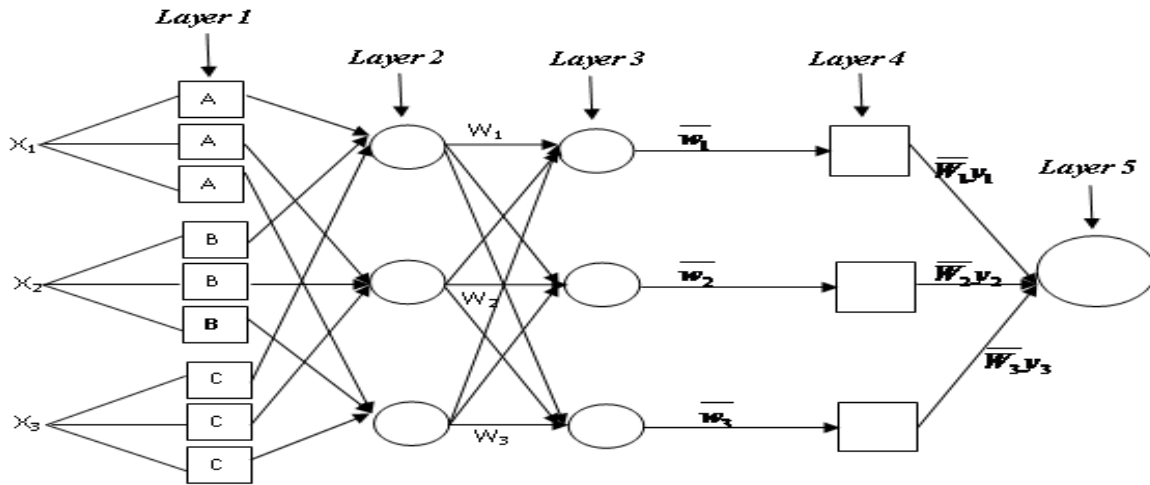

Fig.4. Three inputs ANFIS Model for Handover Process

**Layer1:** Also called fuzzification layer. The node in this layer is referred to as adaptive node and the output  $O_1$  is the membership value of the input signals and the parameters are referred to as antecedence parameters or premise parameters [32].The mathematical model for this layer is given in Equation 1.

$$\mu_A(x_i) = \frac{1}{1 + \left| \frac{x_i - c_i}{a_i} \right|^{2b}} \quad (1)$$

$x_i$  is the input signal

$\mu_A$  is the membership value of the input

$a_i, b, c_i$ , are premise parameters

**Layer 2:** This is called Rule layer and its nodes are fixed and labeled “W”. The output of the layer is the product of the incoming signals and the output of each node.The Mathematical model of this layer is:

$$O_{2,i} = w_i = \mu_{A_i}(x_1) = \mu_{B_i}(x_2) \quad \text{for } i=1,2 \quad (2)$$

**Layer 3:** This is referred to as normalization layer. The nodes in this layer are fixed node labeled “ $\bar{w}$ ”. The output of the node is called normalized output node which is the division of the  $i^{\text{th}}$ rule’s firing strength to the sum of the entire rule’s firing strength [32]. Its mathematical model is given as:

$$O_{3,i} = \bar{w}_i = \frac{w_i}{w_1 + w_2} \quad \text{for } i=1,2 \quad (3)$$

**Layer 4:** Layer 4 is referred to as defuzzification layer with each of its adaptive node. The output of this node is called consequent parameters,  $O_{4,i}$ . The mathematical model of the layer is given as:

$$O_{4,i} = \bar{w}_i f_i = \bar{w}_i (p_i x_1 + q_i x_2 + r_i) \quad (4)$$

Where  $p_i, q_i, r_i$  are consequent parameters

**Layer 5:** This layer is known as summation node and this is where the overall output of the ANFIS structure is given. Theonly node in this layer is called a fixed node. The mathematical model of this layer is given as:

$$O_{5,i} = \sum_i \bar{w}_i f_i = \frac{\sum_i w_i f_i}{\sum_i w_i} \quad (5)$$

$$\begin{aligned} O_{5,1} &= \frac{w_1}{w_1 + w_2} f_1 + \frac{w_2}{w_1 + w_2} f_2 \\ &= \bar{w}_1 (p_1 x_1 + q_1 x_2 + r_1) + \bar{w}_2 (p_2 x_1 + q_2 x_2 + r_2) \\ &= (\bar{w}_1 x_1) p_1 + (\bar{w}_1 x_2) q_1 + (\bar{w}_1) r_1 + \\ &\quad (\bar{w}_2 x_1) p_2 + (\bar{w}_2 x_2) q_2 + (\bar{w}_2) r_2 \end{aligned} \quad (6)$$

*E. SIR, TR AND VEL*

The following parameters are used as input to the ANFIS model for the algorithm to implement the handover decision process and consequently to reduce the handover failure in wireless mobile technologies, they are: Speed of the mobile user, signal to interference ratio, traffic difference.

- *Speed of the Mobile user (VEL):* This is the speed at which the user of mobile equipment moves from one coverage area to another. It is measured in kmph. As one of the causes of handover failure, an effective algorithm using ANFIS takes the speed of the mobile user into consideration before initiation and executing the handover decision between different channels. The value range chosen for this parameter is 0 and 38kmph. Since the speed of the user is irregular, one hundred values are generated randomly for the range of 0 to 38kmph as the different speed at which the user moves within the coverage area.
- *Signal to Interference ratio (SIR):* This is the ratio of the received signal strength to the noise interference measured in dB. The range of this value is taken as 14dB to 22dB and the 100 values of SIR is generated within the given range using the MATLAB environment.
- *Traffic Difference (TR):* This is number of calls within a specified period of time. The lowest number of calls is assumed to be -5 and the highest number of calls is assumed as 5, so the range of traffic difference is taken as -5 to 5. The 100 values between -5 and 5is randomly generated in the MATLAB environment.

**IX. RESULTS AND DISCUSSION**

The outcome of the ANFIS model was evaluated using mean square error (MSE) and then compared with ANN and FIS algorithm using the same data set. The simulation was carried out in MATLAB environment together with the corresponding graphs and diagrams.

*A. Representation of Membership Function of the Input Parameters*

The characteristics of the input parameters (SIR, VEL and TR) of the data-set are grouped under the membership functions using generalized bell shaped representation as shown in Fig. 5, Fig. 6 and Fig. 7 below. The Sugeno model of Fuzzy inference system is adopted for modeling the ANFIS algorithm because of its fast processing speed, flexibility and adaptability with the training of the data-set. The output result

of the simulation gives the received signal strength which is used in making the handover decision.

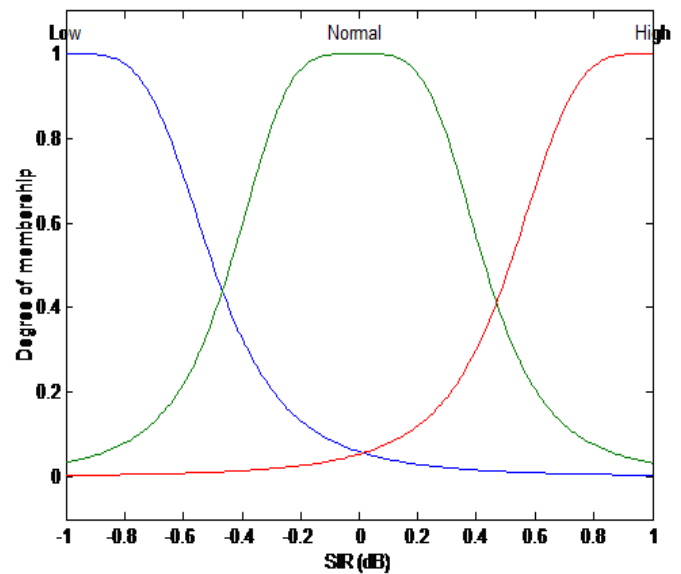

Fig.5. Graphical Representation of the Membership Function of SIR Data Set

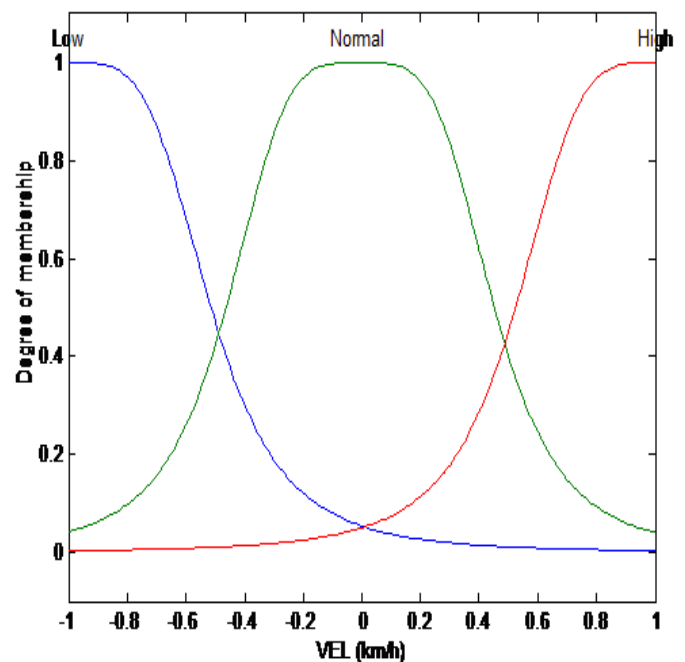

Fig.6. Graphical Representation of the Membership Function for VEL Data Set



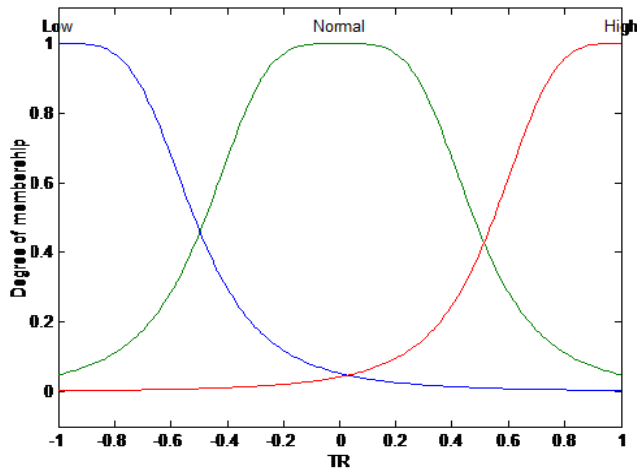

Fig.7. Graphical Representation of the Membership Function for TR Data Set

*B. Performance Evaluation Analysis*

Statistical criteria are used to evaluate the performance of algorithm and these include mean square error and correlation coefficient. These criteria are used to compare the output values of the ANFIS model that was developed with the actual values of the data.

The result of the ANFIS model was evaluated using the mean square error (MSE), this is shown in Fig.8. When the data set for training the model was increased to 80% and the percentage of the data-set for testing and validating the resulting graph is given in Fig.9 and this shows a better performance. For a good quality of service, the handover failure rate must be minimized to as low as possible and this was achieved through the use of ANFIS model algorithm.

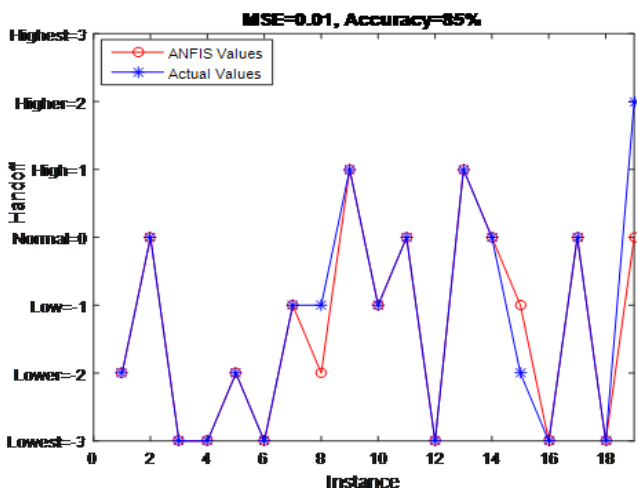

Fig.8. Plot of ANFIS Model Using 60% of the Data Set

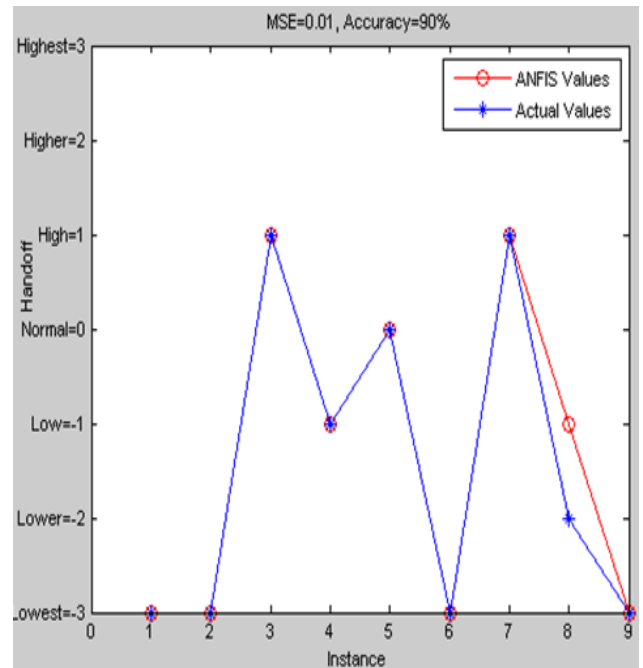

Fig.9. Plot of ANFIS Model Using 80% of the Data Set

*C. Comparison of the ANFIS Model With ANN and FIS Techniques*

The Table 1 below shows the comparison of the output of ANFIS model, FIS and ANN model with the actual values of the data-set used in training the models.

The ANN and ANFIS models have almost a similar pattern as shown in Fig.10 and Fig. 11. These two models show a better performance than the FIS technique for analyzing the same data. The advantage of ANFIS model over the ANN lies in the accuracy and closeness of the model output compared with the actual values used for validation of the result as shown in the Table 1.

Actual Values versus ANFIS, FIS and ANN Values			
Actual Values	Fuzzy(FIS) Output	ANN Output	ANFIS Output
-2	-1	-2	-2
0	0	0	0
-3	-1	-3	-3
-3	-1	-3	-3
-2	-1	-2	-2
-3	-1	-3	-3
-1	-1	-1	-1
-2	-1	-2	-1
1	1	1	1
-1	0	-1	-1
0	0	0	0
-3	-1	-3	-3
1	1	1	1
0	0	0	0
-1	-1	-3	-2
-3	-1	-3	-3
0	0	0	0
-3	-1	-3	-3
0	1	0	2
1	1	1	1

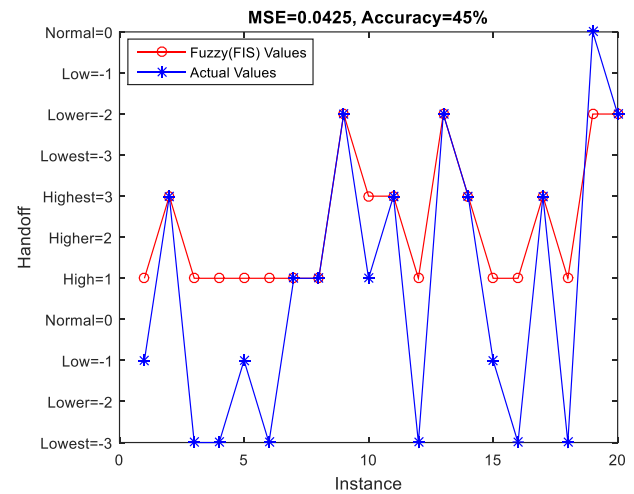

Fig.11. Plot of FIS Model Using the Data Set

**X. CONCLUSION**

The rate of handover failure in mobile wireless network is effectively reduced by using the adaptive network based fuzzy inference system (ANFIS) and since the quality of service is dependent on the rate of handover failure among other factors, it therefore means the quality of service will be enhanced. Also, the more the data-set used in training the ANFIS algorithm model, the more the effectiveness of the algorithm.

Table .1: Comparison of the Output of ANFIS, FIS and ANN Models with Actual Values

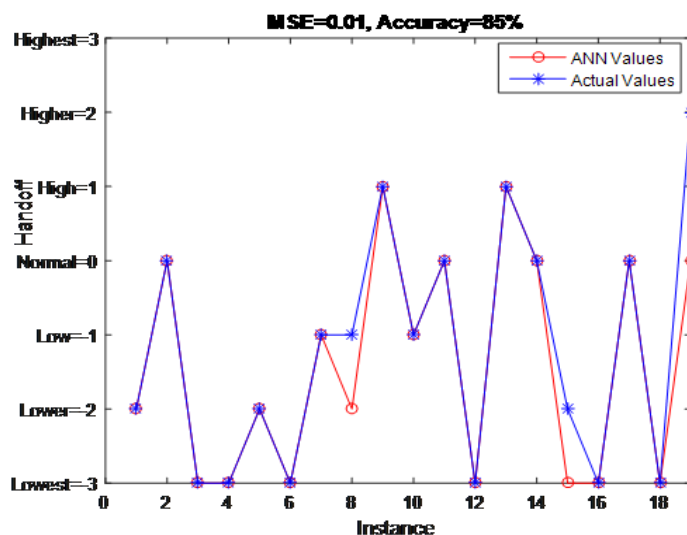

Fig.10.Plot of ANN Model Using the Data Set

**REFERENCES**

- [1]. Hapreet, Kaur and Amrit, Kaur. "Various Handover management techniques in GSM cellular system" International Journal of Advanced Engineering Research and Science, International journal for technological research in Engineering,2014, Vol. 1, pp. 2347-4718. 2349-6495 .
- [2]. Liton, Chandra Paul "Handoff/Handover Mechanism for mobility improvement in wireless communication": Global Journal Inc., Global journal of researches in Electrical and Electronics Engineering, 2013, Vol. 13. 2249-4596.
- [3]. El Fachtali, I, Saadane, R and Koutbi, M "A survey of handovers decision algorithms for next generation wireless networks" International Journal of Advanced Research in Computer and Communication Engineering, 2015, International journal of advanced research in computer and communication Engineering, Vol. 4, pp. 159-165. 2278-1021.

- [4]. Jagadesh, B L; Kullayamma, I "Vivek; Naresh Handover Analysis", International Journal of Engineering Research and applications, 2013 Vol. 1, pp. 287-291. 2248-9622.
- [5]. Shyam, Lal and Deepak, Kumar Panwar "Coverage analysis of handoff algorithm with adaptive hysteresis margin": IEEE, 2007. 10th International Conference on Information Technology, Orissa. pp. 133-138. ISSN 9896007.
- [6]. Amit, Kumar, Ajay, Bhushan and Mahendra, Kumar. "A study of minimization of 2G/3G handover failure" 2012, International journal of advanced research in computer science and software Engineering, pp. 4-7.
- [7]. Amit, Kumar, Yunfei, Liu and Jyotsna, Sengupta "Evolution of Mobile Wireless Communication Networks: 1G to 4G". International Journal of Electronics & Communication Technology, 2010, International journal of Electronics & Communication technology, India Vol. 1, pp. 68-72. 2230-7109.
- [8]. Akhil, Gupta and Rakesh, Kumar Jha. "A Survey of 5G Network: Architecture and emerging technologies" IEEE, 2015, pp. 1206-1232.
- [9]. Gagan, Preet Kaur, Joni, Birla and Jitender, Ahlawat "Generations of Wireless Technology" International Journal of Computer Science and Management Studies, 2011, International Journal of Computer Science and Management Studies, Vol. 11, pp. 176-180. 2231-5268.
- [10]. Bhalla, Anand Vardhan and Bhalla, Mudit Ratana. "A Generation of Mobile wireless technology: A survey". International Journal of Computer Applications, 2010, pp. 26-32.
- [11]. Pereira, Vasco and Tiago, Sousa "Evolution of mobile communications: 1G to 4G" 2nd international working conference on performance modelling and evaluation of heterogeneous network, West Yorkshire, 2004.
- [12]. Mitra, Rupendra Nath and Agrawal, Dharma P "5G mobile technology: A survey", The Korean Institute of Information sciences, 2016, pp. 132-137.
- [13]. Ghebleh, Reza and Ghaffari, Ali. "A comprehensive survey in 5G: The prospect of future communication" Journal of networks and computer application, 2017 pp. 1-32.
- [14]. AAKHIL, GUPTA and RAKESH, KUMAR JHA "A Survey of 5G Network: Architecture and Emerging Technologies". The Journal for open access publishing IEEE Access, 2015, pp. 1206-1232.
- [15]. Xiaohuan, Y; Ahmet, Y; Sathya, N; Ekerciog, L; Sathya, N "A Survey of vertical handover decision algorithms in Fourth generation heterogeneous wireless networks" Computer Networks 54, Vol. 54, 2010, pp. 1848-1863.
- [16]. Abhinav, Kumar and Hemant, Purohit "A comparative study of different types of handoff strategies in cellular systems" International journal of advanced research in computer and communication Engineering, 2013, pp. 4278-4287.
- [17]. Jayasheela, C. S and Gowrishankar. "A Comprehensive parametric analysis of vertical handoff in next generation wireless networks, IOSR Journal of computer Engineering, 2013, pp. 10-17.
- [18]. Abhinav, Kumar and Hemant, Purohit "A comparative study of different types of handoff strategies in cellular systems. 2013, International journal of advanced research in computer and communication Engineering, pp. 2319-5940.
- [19]. Bhuvaneshwari, A and Raj, George Prakash "An overview of vertical handoff making decision making algorithm" International journal of computer network and information security, 2012, pp. 55-62.
- [20]. Abhishek, Dhiman. Vertical and Horizontal Handover in heterogeneous wireless networks. Punjab: Tharpar University, India, 2013.
- [21]. Alotaibi, Nasser M and Alwakeel, Sami S "A Multi-Classifiers-Based Approach for Vertical Handoff Process in Wireless Heterogeneous Networks: Retrospective and Prospective IEEE, 2015, pp. 1-8.
- [22]. Akhila, S and Lakshminarayana, M "Averaging mechanism to decision making for handover in GSM." World academy of Science, Engineering and Technology, 2008, pp. 334-337.
- [23]. Vaibhav, V Kamble; Shubhangi, G Salvi; Bharatratna, P Gwaikwad; Rahul, B Gaikwad "An extensive hypothetical review of call handover process in cellular network" International journal of computational Engineering research, 2014, pp. 2250-3005.
- [24]. Jyh-Shing, F I. "ANFIS: Adaptive Network based Fuzzy Inference System". IEEE Transactions on systems, Man and Cybernetics, 1993, pp. 665-685.
- [25]. Atayero, Aderemi A and Luka, Matthew K "Adaptive neuro-fuzzy inference system for dynamic load balancing in 3GPP LTE". International Journal of advance research in artificial intelligence, 2012 pp. 11-16.
- [26]. Pagyana, Patnaik. "Fuzzy assisted handoff algorithm for micro and macro cellular system". Department of Electronics and communication Engineering, Rourkela, 2010.
- [27]. Volna, Eva. "Introduction to soft computing" Bookboon.com, 2013.
- [28]. Makela, Juha-Pekka "Effect of Handoff algorithm on performance multimedia" Faculty of Technology University of Oulu, 2008.
- [29]. Buragohain, Mrinal "Adaptive network based fuzzy inference system as a tool for system identification with special emphasis on training data minimization" Department of Electronics and Communication Engineering, Indian institute of technology, Guwahati 2008.
- [30]. Kaur, Arshdeep and Kaur, Amrit "Comparison of Mamdani-Type and Sugeno-Type Fuzzy Inference

Systems for Air conditioning System" International journal of soft computing and Engineering, 2012, pp. 323-325.

- [31]. Quang, Hung Do and Jeng-Fung, Chen "A Comparative Study of Hierarchical ANFIS and ANN in Predicting Student Academic Performance" WSEAS transactions on information science and applications, 2013 pp. 369-405.
- [32]. Piero, Bonissone P."Adaptive neural fuzzy inference systems: Analysis and applications". New York, USA : GE CRD, 2002.