

Cost implication of Line Voltage variation on Three Phase Induction Motor operation

Aderibigbe Israel Adekitan*, Bukola Adetokun, Tobi Shomefun, Alex Aligbe

Department of Electrical and Information Engineering
Covenant University, Ota, Ogun State, Nigeria

*Corresponding author, e-mail: ade_kitan@yahoo.com

Abstract

Globally, there is a drive toward ensuring energy efficiency in all aspect of production operations and power supply systems. Industries are the backbone of our modern world, and a significant percentage of industrial operations are motor driven. Three Phase Induction Motor is massively deployed in industries due to its ruggedness, reasonable cost and ease of maintenance. The energy efficiency of the induction motor is affected by the internal configurations of the motor and the nature of the supply. Power supply fluctuations result in power quality issues and its attendant negative effects on equipment operation. This research, studies the cost and performance implication of the effects of balanced over voltage, balanced voltage, balanced under voltage and unbalance voltage on the operation of the three phase induction motor using the peculiarities of Nigeria. The result shows that, there is an increase in operational cost due to increased energy loss in the windings as a result of voltage variations from the balanced state, with balanced over voltage operation showing more cost severity among the voltage variations considered.

Keywords: three phase induction motor, motor performance characteristics, power quality, voltage unbalance, energy efficiency and cost analysis

Copyright © 2018 Universitas Ahmad Dahlan. All rights reserved.

1. Introduction

Line voltage variation is a peculiar, daily power supply challenge in Nigeria. Nigeria's peak energy output as at September, 2017 was 3,880 MW [1], this is about 12.5% of the estimated energy demand of 31,000 MW as at 2015, with an anticipated 10% yearly increase according to the Energy Commission of Nigeria [2]. This has resulted in excessive load shedding, epileptic supply and its associated network issues and supply instability [2, 3]. Currently, power outage to industry stood at an average value of 8.2 hours per day [4].

In Nigeria, a number of companies sprang up in areas that were not initially planned for, and coupled with the insufficient capacity of the supply network, the lines are often overloaded, resulting in increased line voltage drops [5]. The insufficient energy and reliability issues forced many companies to switch to alternatives like petrol and diesel generators, and this increased their operational cost and the level of pollution due to the release of generator exhaust to the environment. Many companies have folded up while others relocated to neighbouring countries due to the realities of the operational environment [3].

In industries, induction motor plays a vital role in daily production processes [6], and it accounts for a significant portion of daily production energy expenses. Induction motors usually drive different loads that are a percentage of its rated power [7-9], this can be as high as 70% or between 3-16% [10]. The performance and efficiency of a three phase induction motor (TPIM) is highly influenced by the quality of the power supply. Power quality issue is a major challenge globally [11, 12], and in Nigeria, it is even more significant due to the unreliability of the supply network [13].

The operation of a TPIM has been studied over the years with a major focus on voltage unbalance scenario. Voltage unbalance has been studied by a number of research works at various percentage of line to line unbalance [14-19], these studies reveals the negative effects of sequence current on motor operation, temperature and efficiency. In voltage unbalance studies, a scenario in which the positive sequence voltage is greater than the rated average voltage is referred to as over-voltage unbalance condition while under-voltage unbalance condition is when the positive sequence voltage is below the rated supply voltage.

This research is focused on the steady state analysis of a TPIM, operating under Balanced Rated Voltage (BV), Balanced Under-Voltage (BUV), Balanced Over-Voltage (BOV) and Unbalance Voltage (UBV) conditions. According to [20], BOV is a supply scenario in which the three phase

voltages are both individually, and equally greater in magnitude than the rated supply voltage value, while BUW is a supply scenario in which the three phase voltages are both individually, and equally lower in magnitude than the rated supply voltage value. Voltage unbalance is a scenario in which the line voltages of the three phases of the supply are not equal. These supply variations are major power quality issues that determine TPIM operational cost and efficiency.

2. Three Phase Induction Motor

For a three phase induction motor as shown in Figure 1, the synchronous speed n_s is given by

$$n_s = \frac{120 \times f_s}{P} \quad (\text{rev/min}) \quad (1)$$

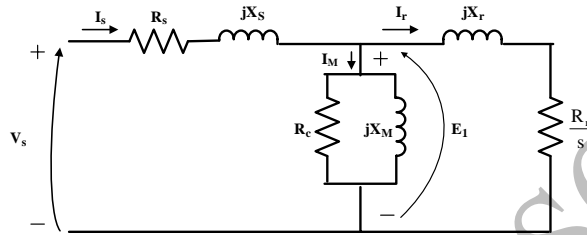

Figure 1. The Per Phase Equivalent Circuit of a 3-phase induction motor

The effective impedance of the magnetizing circuit is given by

$$Z = R_c // jX_m = \frac{jR_c X_m}{R_c + jX_m} \quad (2)$$

The motor impedance is given as

$$Z_m = R_s + jX_s + \frac{Z \times (jX_r + \frac{R_r}{s})}{Z + jX_r + \frac{R_r}{s}} \quad (3)$$

Let I_s be the stator current,

The Voltage E_1 can be obtained from equation (5)

$$E_1 = I_s \times \frac{Z \times (jX_r + \frac{R_r}{s})}{Z + jX_r + \frac{R_r}{s}} \quad (4)$$

$$\text{The rotor current } I_r = \frac{Z}{Z + jX_r + \frac{R_r}{s}} \times I_s \quad (5)$$

The stator and rotor copper losses are obtained as follows

$$P_s = 3I_s^2 R_s \quad (6)$$

$$P_r = 3I_r^2 R_r \quad (7)$$

$$\text{The core loss } P_c = \frac{3E_1^2}{R_c} \quad (8)$$

The power converted from electrical to mechanical form, which is also referred to as developed mechanical power is given by

$$P_{conv} = 3I_r^2 R_r \left(\frac{1-s}{s} \right) \quad (9)$$

Given the rotational losses P_{rot} (windage and friction) and other stray losses P_{stray} , the output power can be obtained from

$$P_{out} = P_{conv} - P_{rot} - P_{stray} \quad (10)$$

The developed or induced torque of the machine is the torque generated due to the conversion of electric power to mechanical power.

$$T_{dev} = \frac{P_{conv}}{\omega_m} \quad (11)$$

2.1. Maximum Torque variation

To determine the maximum torque fluctuations as the voltage supply swings from, BUW, BV to BOV, the Thevenin equivalent of the induction motor model shall be applied. By applying Thevenin's theorem to the per-phase stator circuit of Figure 1, the following parameters can be determined.

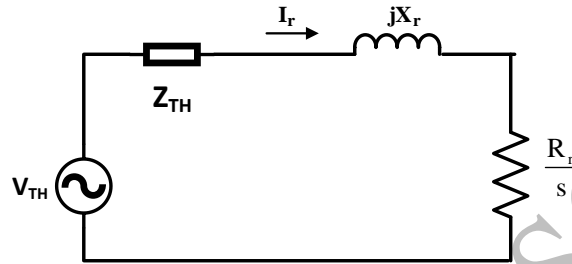

Figure 2. Thevenin equivalent of a 3-phase induction motor

The slip at maximum torque is obtained as follows

$$S_{max} = \frac{R_r}{\sqrt{R_{Th}^2 + (X_{Th} + X_r)^2}} \quad (12)$$

$$T_{max} = \frac{3V_{TH}^2 R_r}{s\omega_s \left(R_{TH} + \frac{R_r}{s} \right)^2 + s\omega_s (X_{TH} + X_r)^2} \quad (13)$$

2.2. Voltage Unbalance Analysis

The voltage unbalance study is achieved using the equivalent T-circuit shown in Figure 3, based on the sequence component analysis of the TPIM [19, 21].

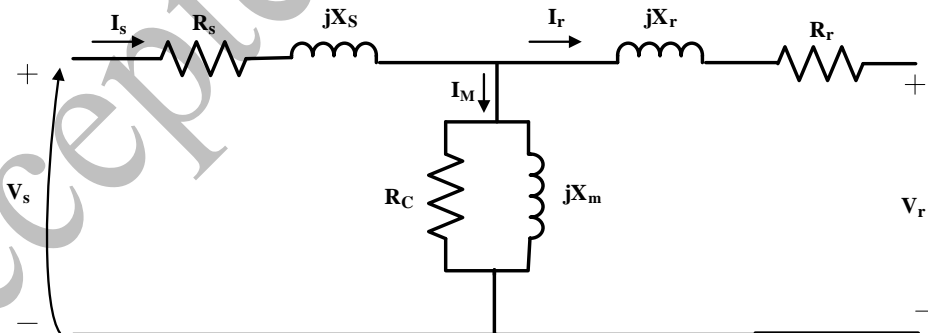

Figure 3. Equivalent T-circuit of a 3-phase induction

According to the National Electrical Manufacturers Association Motor and Generator Standard (NEMA MG1.1993), line voltage unbalance in a three phase supply is defined as follows

$$UBV (\%) = \frac{(\text{max imum voltage deviation from average line voltage})}{(\text{average line voltage magnitude})} \times 100\% \quad (14)$$

$$= \frac{\text{Max} [|V_{ab} - V_{Lavg}|, |V_{bc} - V_{Lavg}|, |V_{ca} - V_{Lavg}|]}{V_{Lavg}} \times 100\% \quad (15)$$

$$\text{Where } V_{Lavg} = \frac{(V_{ab} + V_{bc} + V_{ca})}{3} \quad (16)$$

$$\text{The positive sequence slip } s_1 = \frac{n_s - n}{n_s} \quad (17)$$

$$\text{Negative sequence slip } s_2 = 2 - s \quad (18)$$

$$\text{The sequence stator impedance } Z_{si} = R_{si} + jX_{si} \quad (19)$$

$$\text{The sequence rotor impedance } Z_{ri} = R_{ri} + jX_{ri} \quad (20)$$

$$\text{The Magnetizing circuit admittance } Y_m = \frac{R_c + jX_m}{R_c \cdot jX_m} \quad (21)$$

The sequence rotor component can be obtained using equation (23)

$$\begin{pmatrix} V_{ri} \\ I_{ri} \end{pmatrix} = \begin{pmatrix} 1 + Y_{mi} Z_{ri} & (Y_{mi} Z_{si} Z_{ri}) - Z_{si} - Z_{ri} \\ -Y_{mi} & 1 + Y_{mi} \cdot Z_{si} \end{pmatrix} \begin{pmatrix} V_{si} \\ I_{si} \end{pmatrix} \quad (22)$$

3. The Simulation Result and Analysis

A Matlab simulation was carried out using seven voltage supply scenarios, and these are $BUV = 0.9 BV$, $BUV = 0.95 BV$, BV , $BOV = 1.05 BV$, $BOV = 1.1 BV$, $5\% UBV$ and $10\% UBV$ supply conditions. The induction motor for this study has the following parameters: $415V$, $X_m = 24.6\Omega$, $X_s = 0.681\Omega$, $X_r = 0.657\Omega$, $R_r = 0.64\Omega$, $R_s = 0.56\Omega$, $R_c = 941\Omega$, rated slip = 0.04 , mechanical losses = $227W$.

For the steady state analysis (BUV , BV , BOV) the slip was varied around the rated slip from 0 to 0.08 , so as to study the motor performance within this region, while for the unbalance voltage condition, the percentage unbalance ranged from 0 to 10% . The result of the simulation is shown by the graphs of Figure 4 to Figure 6 for the balanced voltage cases, and Figure 7 to Figure 9 for the unbalanced voltage cases while Figure 10 to Figure 13 details the comparative analysis for the seven scenarios considered.

Table 1 shows the comparative performance of the TPIM specifically at the rated slip of 0.04 .

Table 1. Motor performance result at rated slip

PARAMETER	10% BUV	5% BUV	BV	5% BOV	10% BOV	5% UBV	10% UBV
Total Loss (W)	1,070.40	1,166.70	1,268.30	1,375.00	1,486.90	1,303.60	1,451.20
Shaft Power (W)	7,138.00	7,979.00	8,866.00	9,798.00	10,776.00	8,649.80	8,448.90
Input Power (W)	8,209.00	9,146.00	10,134.00	11,173.00	12,262.00	9,974.00	9,900.00
Apparent Power (VA)	10,055.00	11,203.00	12,414.00	13,686.00	15,021.00	12,238.00	12,206.00
Efficiency (%)	86.96	87.24	87.49	87.69	87.87	86.93	85.34
Power Factor	0.8164	0.8164	0.8164	0.8164	0.8164	0.8151	0.8111
Max Torque (Nm)	213.89	238.32	264.07	291.13	319.52	259.00	254.35

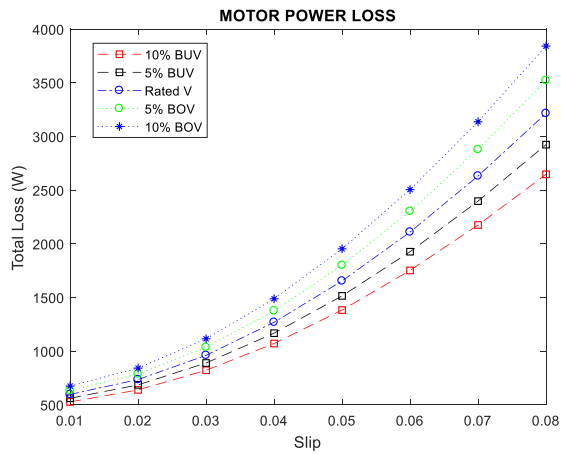

Figure 4. Total energy loss in the motor

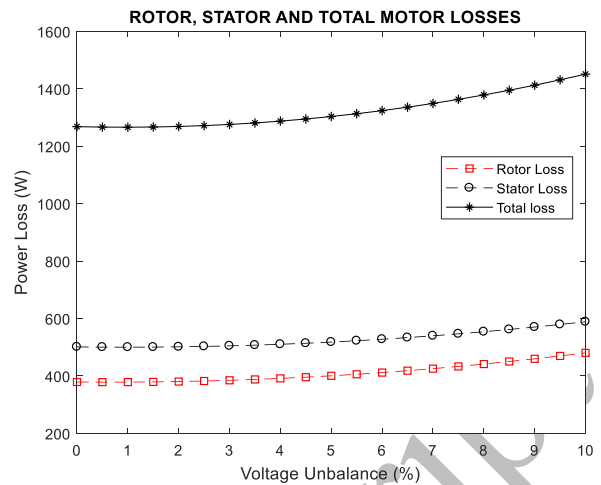

Figure 7. Rotor, Stator and Total loss with increasing unbalance

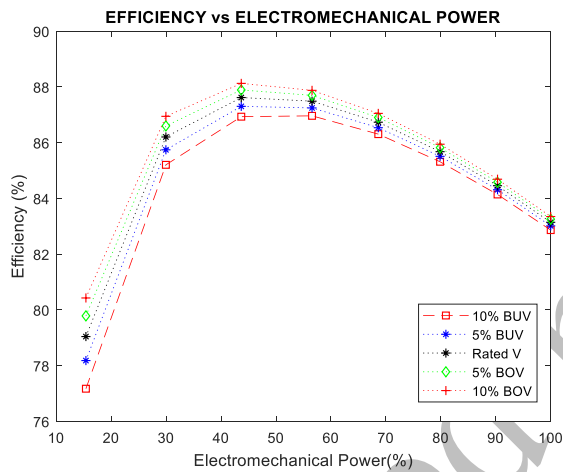

Figure 5. A plot of efficiency against electromechanical power

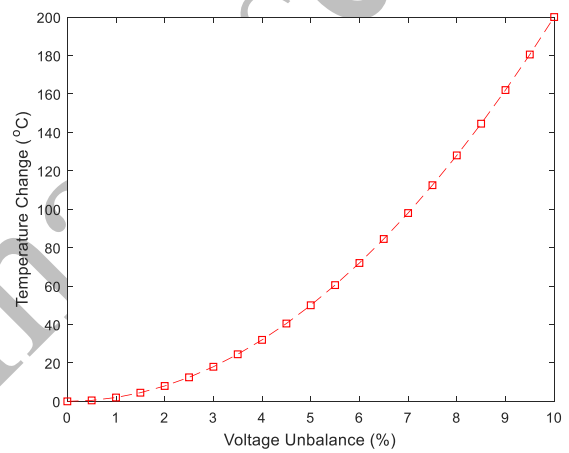

Figure 8. Temperature rise with increasing percentage voltage unbalance

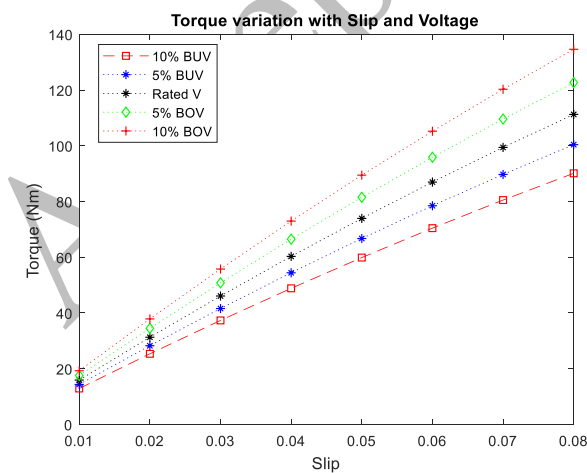

Figure 6. Motor output torque variation

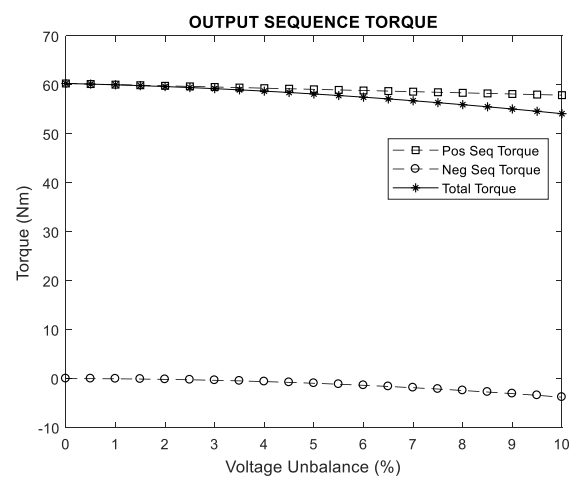

Figure 9. A plot of sequence torque components

From the data in Table 1, the highest total loss occurred during BOV conditions, and comparatively between BOV and UBV at both 5% and 10% values, the losses are more significant for BOV, and this shows that though research focus is more on unbalance voltage conditions, operation under BOV actually induces more losses. The shaft power is highly reduced during BUV conditions and this will affect the ability of TPIM to carry the rated load, while for the UBV there is a slight drop in shaft power from the BV value, and for the BOV supply condition, the shaft power increased substantially and this may eventually damage the motor if not checked. During under voltage conditions (BUV), when the input voltage is below the rated value, the motor shaft power and torque are below the rated values and as such, when loaded, the motor will not be able to carry its rated load effectively, and if there is a significant reduction in voltage the motor will start to stall and draw more current to compensate for the reduced voltage; this will ultimately trip overcurrent protective devices or burn off the motor winding. The TPIM will completely stop if the voltage is extremely low. Figure 11 shows comparatively the output torque variation for the seven cases using the BV torque value as reference.

The maximum apparent power of 15,021 VA was recorded for the 10% BOV supply condition as compared with 12,206 VA for the 10% UBV condition, this further emphasizes the increased energy demand and threat posed by over voltage to TPIM. For the voltage unbalance scenario, the average voltage varied from 415V to 406.7V as the percentage unbalance is increased from 0 to 10%, this reduction in average voltage accounts for the drop in input power for the UBV cases. The real and reactive input power of the TPIM is shown in Figure 10 as a percentage of BV value.

At slip S_{max} , the maximum achievable torque is highest for the 10% BOV at 319.52Nm, this torque is significantly higher than the rated value, and if the increase in voltage persists, it may produce a very high centrifugal force that may throw off the rotor winding from the slots. BOV operation stimulates excessive increase in current, and UBV stimulates increase in negative sequence current, the increase in motor current due to these conditions may result in line voltage fluctuations on nearby loads on the same supply with the motor. As the current increases, ultimately, the motor magnetic field may be saturated.

From Figure 4, it can be seen that there is a significant increase in losses as the slip increases for the balanced voltages while for the unbalance voltage as shown in Figure 7, TPIM losses increases with increasing percentage unbalance, the heat produced by this losses will increase the motor temperature as shown in Figure 8 and this may destroy the motor insulation.

Voltage unbalance creates negative sequence currents and torque, Figure 9 shows a reduction in total torque due to the negative sequence torque which opposes the useful positive sequence torque.

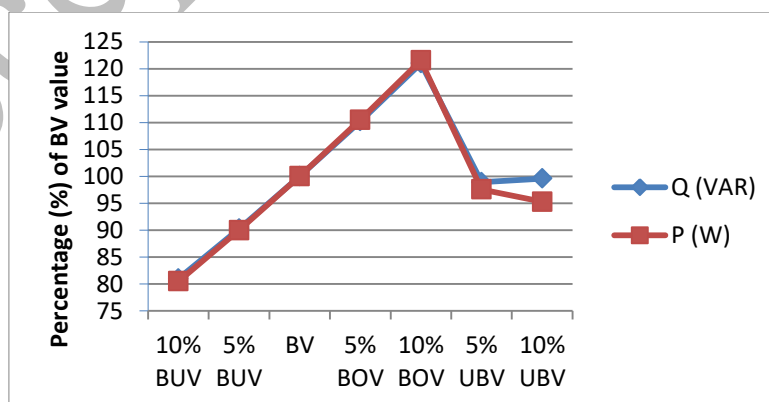

Figure 10. Real and reactive input power for the voltage variations

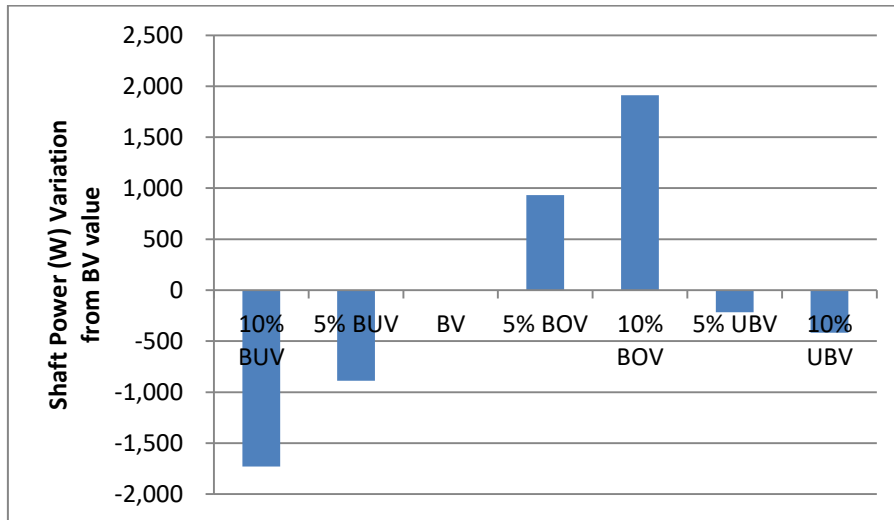

Figure 11. Shaft power variation with respect to the BV value

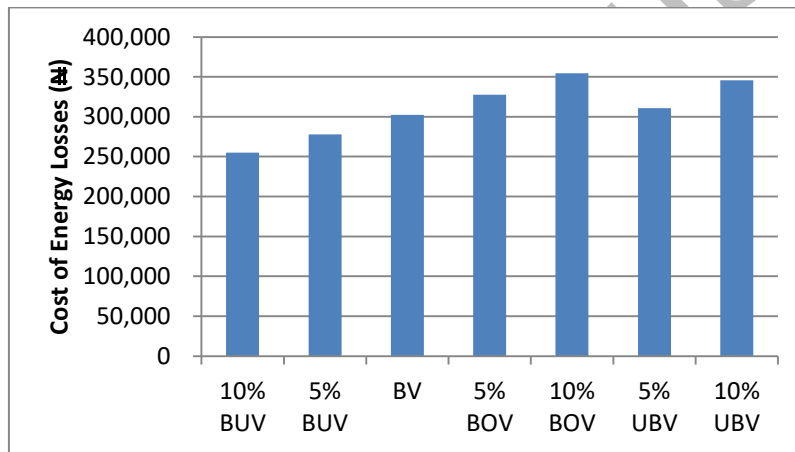

Figure 12. The cost implication of energy losses in Naira

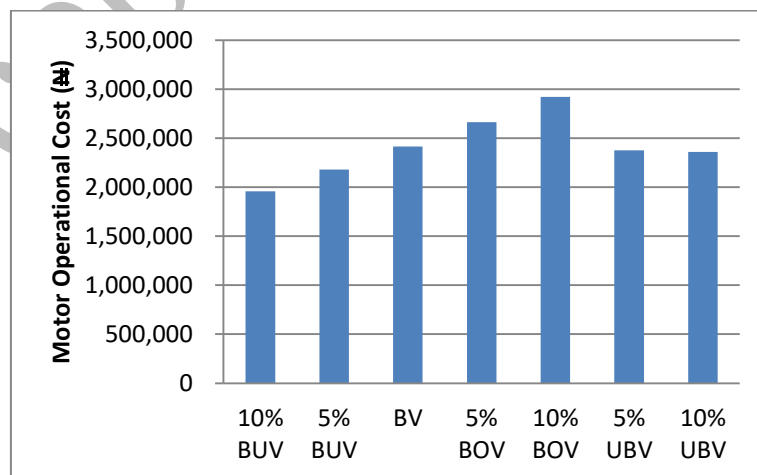

Figure 13. Total cost of running TPIM per annum

The average energy rate in Nigeria per kWh is N27.20, based on this figure a cost analysis is developed for the financial implication of running the TPIM for 24 hours a day [22], for a whole year. From Figures 12 and 13, the cost of energy losses alone, and also, the total cost of energy for operating the motor for a whole year are both highest for the 10% BOV case. It is vital to note that the 5% BOV follows next in motor yearly operational cost ranking. This further establishes the significance of BOV as compared with UBV.

4. Conclusion

This research study analysed the effects of BUV, BOV and UBV on the operation and energy efficiency of a three phase induction motor as compared with the BV operation. The result shows that BUV reduces the performance of the motor as the motor may stall or draw more current to compensate for the reduced voltage. During BOV conditions excessive energy is wasted as heat in the windings, increasing the winding temperature and weakening the winding insulation. Excessive BOV stimulates increased current which produces more torque that may damage the motor if significantly higher than the rated torque, coupled with the increased heat and risk of insulation failure.

From the comparative result analysis, the losses and energy requirements due to BOV, the cost implication of the energy losses and the total annual energy cost for running the motor is higher for the BOV than the UBV. UBV has triggered many research studies and interests due to the undesirable effects of the negative sequence components, with less attention paid to BOV operational condition. This research has shown that in a country like Nigeria, with supply reliability and stability issues, BOV is a potent threat to the efficient and economic operation of the TPIM motor.

Acknowledgement

The Authors appreciate Covenant University Centre for Research, Innovation and Discovery for supporting the publication of this research.

References

- [1] NBS, "Daily Energy Generated and Sent Out (Q3 2017)," National Bureau of Statistics, Nigeria 2017.
- [2] C. A. Awosope, "Nigeria Electricity Industry: Issues, Challenges and Solutions," in Covenant University 38th Public Lecture, Public Lecture Series. vol. 3, ed, 2014.
- [3] M. O. Oseni, "An analysis of the power sector performance in Nigeria," *Renewable and Sustainable Energy Reviews*, vol. 15, pp. 4765-4774, 2011/12/01/ 2011.
- [4] H. N. Amadi, E. N. C. Okafor, and F. I. Izuegbunam, "Assessment of impact of outages in selected electricity intensive industries in Nigeria," *International Journal of Research in Engineering & Technology* vol. 4, pp. 9-24, Oct 2016 2016.
- [5] C. P. Barros, A. Ibiowie, and S. Managi, "Nigeria's power sector: Analysis of productivity," *Economic Analysis and Policy*, vol. 44, pp. 65-73, 2014/03/01/ 2014.
- [6] H. Taha, M. Ammar, and M. Moustafa Hassan, "Induction Motors Stator Fault Analysis based on Artificial Intelligence," *Indonesian Journal of Electrical Engineering and Computer Science*, vol. 2, pp. 69-78, 2016.
- [7] P. Gnacinski and T. Tarasiuk, "Energy-efficient operation of induction motors and power quality standards," *Electric Power Systems Research*, vol. 135, pp. 10-17, 2016/06/01/ 2016.
- [8] E. B. Agamloh, "The partial-load efficiency of induction motors," *IEEE Trans. Ind. Appl.* , vol. 45, pp. 332-340, February, 2009 2009.
- [9] E. B. Agamloh, *The Partial Load Efficiency of Induction Motors* vol. 45, 2007.
- [10] M. Thirugnanasambandam, M. Hasanuzzaman, R. Saidur, M. B. Ali, S. Rajakarunakaran, D. Devaraj, et al., "Analysis of electrical motors load factors and energy savings in an Indian cement industry," *Energy*, vol. 36, pp. 4307-4314, 2011/07/01/ 2011.
- [11] S. Shahbudin, Z. F. Mohamad, S. I. Suliman, M. Kassim, and R. Mohamad, "Classification of power quality disturbances at transmission system using support vector machines," *Indonesian Journal of Electrical Engineering and Computer Science*, vol. 6, pp. 310-317, 2017.
- [12] C. Bharatiraja and V. Harish Chowdary, "Real time power quality phenomenon for various distribution feeders," *Indonesian Journal of Electrical Engineering and Computer Science*, vol. 3, pp. 10-16, 2016.
- [13] A. E. Airoboman, E. A. Ogujor, and I. Kokakwu, "Reliability analysis of power system network: A

- case study of transmission company of Nigeria, Benin City," in 4th IEEE PES and IAS PowerAfrica Conference, PowerAfrica 2017, Accra; Ghana, 2017, pp. 99-104.
- [14] M. Siddique, G.S.Yadava, and B. Sing, "Effects of Voltage Unbalance on Induction Motors," in In Conference Record of the 2004 IEEE International Symposium on Electrical Insulation, Indianapolis, 2004.
- [15] P. Pillay, P. Hofmann, and M. Manyage, "Derating of induction motors operating with a combination of unbalanced voltages and over or undervoltages," IEEE Trans. Energy Conservation, vol. 17, 2002.
- [16] V. J. Annette, "Voltage unbalance: Power quality issues, related standards and mitigation techniques," Electric Power Research Institute, EPRI, Palo Alto, CA 1000092, 2000.
- [17] P. Pillay and M. Manyage, "Definitions of voltage unbalance," IEEE Power Engineering Review, vol. 21, pp. 50-51, 2001.
- [18] J. E. Williams, "Operation of 3-Phase Induction Motors on Unbalanced Voltages [includes discussion]," Transactions of the American Institute of Electrical Engineers. Part III: Power Apparatus and Systems, vol. 73, p. 1, 1954.
- [19] A. Adekitan, A. Ogunjuyigbe, R. Ayodele, and I. Samuel, "The performance of a 3-Phase Induction Machine under Unbalance Voltage Regime," Journal of Engineering Science and Technology Review, vol. 10, pp. 136-143, 2017.
- [20] G. Kini, R. Bansal, and R. S. Aithal, Impact of voltage unbalance on the performance of three-phase induction motor vol. 24, 2006.
- [21] W. H. Kersting and W. H. Phillips, "Phase Frame Analysis of the Effects of Voltage Unbalance on Induction Machines," IEEE Transactions on Industry Applications, vol. 32, pp. pp.415-20, 1997.
- [22] A. E. Airoboman, P. A. Amaize, A. E. Ibhaze, and O. O. Ayo, "Economic Implication of Power Outage in Nigeria: An Industrial Review," International Journal of Applied Engineering Research, vol. 11, pp. 4930-4933, 2016.