

Comparative Study of MIMO-OFDM Channel Estimation in Wireless Systems

Obinna Okoyeigbo, Kennedy Okokpujie, Etinosa Noma-Osaghae,
Charles U. Ndujuba, Olamilekan Shobayo, Abolade Jeremiah

Abstract – Determining the channel characteristics and how it affects transmitted signals is known as channel estimation. MIMO OFDM is a combination of MIMO and OFDM techniques. In this paper, comparative studies of MIMO, MISO and SISO channel estimation, using OFDM was performed. The block type and the comb type pilot arrangements were compared, and also various interpolation techniques were also compared to determine the optimum performance. The Bit Error Rate and MSE were employed as the performance metrics. This research was carried out by modeling and simulating the wireless communication system using MATLAB. It was discovered that the FFT interpolation has the best performance compared to other interpolation techniques. It was also shown that the MMSE outperforms the LS, but this is achieved at the cost of system complexity. An improvement in system performance was also observed with an increase in the number of antennas (i.e SISO, MISO and MIMO respectively), and also the OFDM helps combat interference and improves the bandwidth efficiency. **Copyright** © 2018 Praise Worthy Prize S.r.l. - All rights reserved.

Keywords: MIMO, MISO, SISO, OFDM, Bit Error Rate, Channel Estimation, Wireless Communication

I. Introduction

MIMO is the acronym for systems that have multiple inputs and multiple outputs. The input and output pairs are particularly the number of antennas that a communications system has. This smart way of antenna propagation has led to significant improvements in communication technology. MIMO systems have helped to increase communication system capacity linearly [1]-[25]. This increase is dependent on the amount of antenna used. MIMO systems can increase the frequency spectrum efficiency of the communication system without the need for more bandwidth and power [1].

There is need for the receiver to have prior knowledge of the communication channel for it to be able to detect the signal correctly. This is only possible if the receiver can monitor the changes that occur in the communication channel. This is generally known as channel estimation and it forms an essential part of any communications system [2]. There are two modes of channel estimation.

Channel estimation can either be pilot-based or decision-directed [3]. For pilot based systems, the ability to accurately estimate the communication channel is based on a pre-shared symbol known as the pilot symbol.

This is shown in Figure 1.

In this paper, channel estimation in a wireless communication system was simulated using MATLAB [24], [25]. For the simulation to be effective, a system with a transmitter, receiver and channel was implemented.

The Bit Error Rate (BER) to the Signal-to-Noise ratio (SNR) was used as the metric for performance analysis.

This is done for the various interpolation techniques. The various interpolation techniques were evaluated to determine the most effective interpolation technique. The Mean Square Error (MSE) for the two types of pilot arrangements which are (the comb and the block types) was got to determine the most effective pilot arrangement to use. BER values of the systems with and without OFDM for estimating channels with SISO were also tried. The BER for MISO (2X1) and SISO channels were compared to determine the best channel estimation technique to be used. Lastly, BER values for MISO LS channel estimation were compared. A threshold was set for the pilot insertion ratio, to determine the most effective channel estimation technique through interpolation.

II. Foundational Concepts

II.1. Orthogonal Frequency Division Multiplexing

Orthogonal Frequency Division Multiplex (OFDM) is a modulation technique that is well suited to MIMO channels.

The principle of operation of the OFDM is the division of data streams with very high bit rates into several parallel streams with lesser bit rates, with each stream being modulated on distinct subcarriers [4].

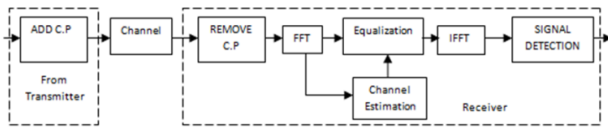

Fig. 1. Block diagram showing channel estimation and equalization at the receiver

OFDM divides the obtainable bandwidth into a number of lesser bands or sub-bands. This allows data to be transmitted without any dependence on the other bands of frequency.

The smart way of selecting a channel in this type of communication system with multiple paths is the splitting of these channels into different amounts of flat sub-channels which have orthogonal subcarriers. OFDM has a robust capability of being able to achieve orthogonality in both frequency and time domain. This characteristic makes the OFDM the best multiplexing technique that can provide a satisfactory means of working with fading channels that are frequency selective, multipath and signal interference amongst others with less system sophistication [5], [6].

Coding and interspersing of the frequency components of subcarriers can also be exploited by OFDM to achieve diversity in frequency for channel optimization. The available spectrums of the frequency channels can also be fully utilized by the OFDM because of its unique characteristic of ensuring these separate parallel orthogonal subcarriers overlap.

Figure 2 is a pictorial representation of the OFDM system.

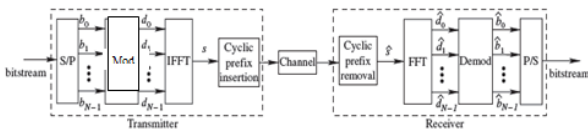

Fig. 2. Block Diagram of an OFDM system [7]

OFDM can be reliably referred to a case of Frequency Division Multiplexing (FDM) only with a restraint of orthogonality in the subcarriers. In realizing this orthogonality, the subcarriers are arranged to generate a spacing of $\Delta f = k/T$. T denotes the duration of the symbol and k represents a positive going number which is seeded the value of one (1) most times. This is the reason OFDM has the unique ability to partially overlap subcarriers without causing any distortion to the signals conveyed by the adjacent subcarriers.

As shown in Figures 3, the crest of the individual subcarriers corresponds with a null value of the interfering neighbor subcarrier, which eliminates distortion of the signals.

The illustration shown in the first part of Figures 3, depicts a conventional FDM system where there is no form of orthogonality between the subcarriers. In the second part of Figures 3, there is orthogonality between the subcarriers leading to more efficient use of available bandwidth. In the discrete time domain, the best tools

that can be used to simulate Orthogonal Frequency Division Multiplexing are the Fast Fourier Transform (FFT) and Inverse Fast Fourier Transform (IFFT).

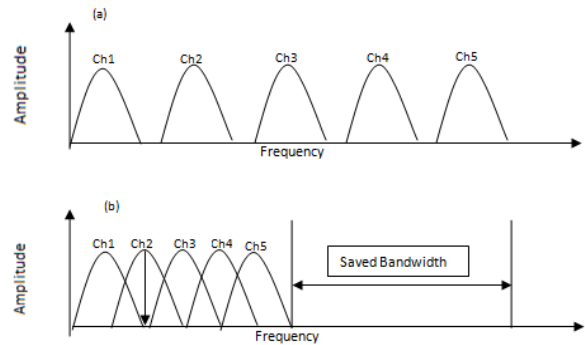

Fig. 3. Comparison between (a) Conventional FDM and (b) OFDM

After the signal has been reversed to the analog domain using the IFFT, a cyclic prefix is attached to the signal to effectively show the domain in which the signal is represented. This scenario is reversed at the receiving end. To eliminate ISI, the frequency selective channel must be split into flat fading channels [7], [8]. Delays generated during the dispersion of the spectrum might cause loss of orthogonality. This can lead to errors.

However, this issue is eliminated by the cyclic prefixing of the signal after FFT and the orthogonality is upheld.

The process of cyclic prefixing is simply repeating the first section of the pilot symbol after the end of the first symbol. Simply put, there is an extension of the OFDM frame (which can be referred to as the delay). This increase in length of the frame helps eliminate interference. The cyclic prefix and the OFDM frame (which gives the total frame length), must be much higher in value than the impulse response of the channel to be able to eradicate the effect of interference (ISI).

The cyclic convolution of the OFDM channel can be achieved using cyclic prefixes.

II.2. Multiple- Input Multiple- Out (MIMO) System

MIMO techniques find its maximum and efficient use in wireless systems. They considerably fix the performance and competency of wireless systems through multiplexing and increased gain (due to the diversity of the channel). In relation to the energy of a transmitted bit, the multiplexing capacity of MIMO systems translate into increased data rate whereas channel diversity culminates into lower error rate. The Binary Error Rate (BER) takes care of the issue of fading of the transmitted signals. The combination of OFDM and MIMO has generated a lot of attention because it promises to provide a lot of ways to manipulate wireless systems to generate desirable results [9], [10], and [11].

There has been significant gain due to low BER and increase in channel capacity for multiple users MIMO than for single user MIMO.

II.3. MIMO-OFDM

Figure 4 is a depiction of the MIMO-OFDM block. MIMO can be used in conjunction with OFDM to form a compound MIMO-OFDM system. The combination of these techniques has been found to be able to produce a system that is bandwidth efficient, free from the interference caused by ISI, able to provide high channel capacity and improved data rate.

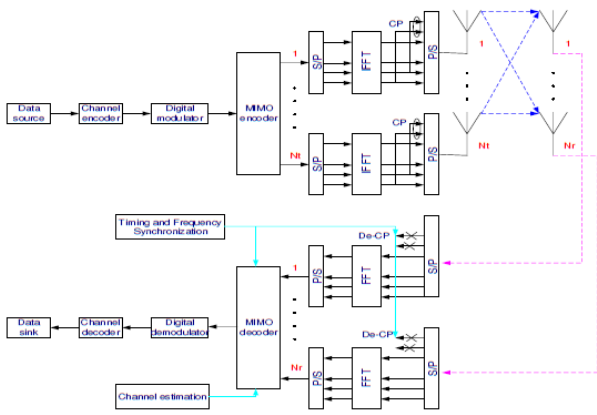

Fig. 4. Channel Estimation Block Diagram for the MIMO-OFDM System [11]

The usually selective fading channel issue in OFDM-MIMO systems are usually turned into orthogonal fading channels that are flat with the aid of IFFT and FFT as discussed earlier. The combined MIMO-OFDM has been proven to achieve enhanced system performance than the usual SISO-OFDM.

In contrast to SISO systems, the delay spread spectrum achievable in MIMO-OFDM systems delivers a combination of increased sub-band channels and multiplexing gain compared to flat-fading channels [12].

This is obtained by bit-stream demultiplexing to yield lesser sub-streams, and modulating the individual sub-streams with the help of OFDM before transmitting the signal.

From Figure 4 it can be observed that each of the signal coming from MIMO antennas are decomposed into parallel subcarriers using serial to parallel conversion, before the signal is modulated using the IFFT transformation. The signal is then appended with a cyclic prefix before it is then transmitted. At the receiver, the entire process is reversed.

II.4. Pilot Arrangements in Channel Estimation

There are basically two types of pilot arrangements in channel estimation. Pilots are known symbols, which are transmitted and used to estimate the channel. They could be placed either at the beginning of the entire frame or at the end of the frame. Often, the pilots can also be placed at specific intervals within the frame. The authors in [13], [14] presented an issue of pilot contamination during channel estimation. This stems from disagreement of orthogonality between the pilots of the information

signal and the interfering pilots. This leads to poor performance of the system due to interference at the receiver. But it should be noted that if the amount of pilots used is increased, the performance can be made better by increasing the channel's estimate. However, the channel's bandwidth will suffer because of the increased amount of pilots used. To achieve a better system, in which the amount of bandwidth occupied by the pilot system is reduced drastically, our attention would be focused on the use of interpolation to get the estimate of the channel's frequency response between pilots without affecting the system and accuracy of channel estimations.

Comb and block pilot arrangements are the two types of pilot systems that are available for channel estimation techniques [15], [16]. The main difference between the comb and the block type arrangement is that the pilot tones are inserted into each OFDM symbol at periodic intervals of the subcarrier frequency in the comb type, while the pilots are inserted within the frequency subcarrier in the block type arrangement. Transmission is done periodically in the time domain to achieve channel estimation. Figures 5 depict the comb-type and the block-type arrangements of pilots respectively.

It can be observed that each of the signal coming from MIMO antennas are decomposed into parallel subcarriers using serial to parallel conversion, before the signal is modulated using the IFFT transformation. The signal is appended with a cyclic prefix before it is then transmitted. At the receiver, the entire process is reversed.

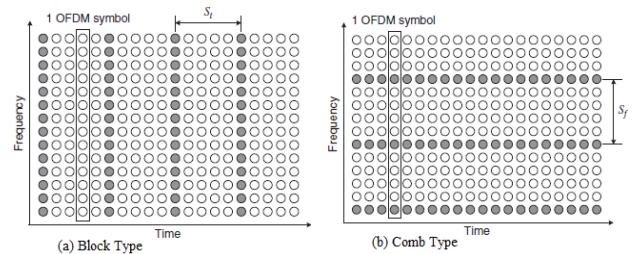

Figs. 5. Diagram of the Block-type and Comb-type Arrangement [2]

Figure 5(a) depicts the block pilot arrangement. It can be seen from the diagram that the pilot is placed at regular intervals which coincides with the frequency of the coherent time so as to deal with the varying time of the channel which corresponds to Equation (1) [17], where the period of the block is represented by S_i :

$$S_i \leq \frac{1}{f_{Doppler}} \quad (1)$$

The comb type pilot arrangement is given in Figure 5(b). In this arrangement, the pilots are carefully placed in a repetitive and orderly manner. This arrangement provides a form of bandwidth coherence that makes it possible to keep track of the frequency selective fading channel. This is achieved by making the comb-type pilots duration smaller than the channel's coherent bandwidth.

The inverse of the signal's maximum delay spread spectrum (σ_{max}) gives a close estimate of the coherence of the channel's bandwidth. The spacing between the pilots in the comb type, can be found using Equation (2):

$$S_f \leq \frac{1}{\sigma_{max}} \quad (2)$$

where the separation times or period of the pilots is denoted by S_f [18], [19], [20],[21].

II.5. Pilot Symbol Aided Channel Estimation

Here, the received signal is multiplied by the inverse of the transmitted pilots, to generate the channel estimate. This gives an accurate estimate of the channel, and in turn provides better performance of the system.

But the placements of these pilot systems have increased the overall bandwidth of the channel. Also, the cost implication of this method cannot be overlooked. To remove this problem, the interpolation technique is utilized. Equation (3) is a Diagonal Matrix that can be used to place training symbols or pilots within K subcarriers, provided that the OFDM subcarriers are orthogonal and do not have inter channel interference [3]:

$$X = \begin{bmatrix} X[0] & 0 & \dots & 0 \\ 0 & X[1] & & \vdots \\ \vdots & & \ddots & 0 \\ 0 & \dots & 0 & X[K-1] \end{bmatrix} \quad (3)$$

where $k = 0, 1, 2 \dots N-1$, $X[k]$ denotes a k th subcarrier's pilot symbol, which has a mean value of: $E\{N[k]\}=0$ and variance of: $Var\{N[k]\}= \sigma_x^2$:

$$Y \triangleq \begin{bmatrix} Y[0] \\ Y[1] \\ \vdots \\ Y[K-1] \end{bmatrix} = \begin{bmatrix} X[0] & 0 & \dots & 0 \\ 0 & X[1] & & \vdots \\ \vdots & & \ddots & 0 \\ 0 & \dots & 0 & X[K-1] \end{bmatrix} \cdot \begin{bmatrix} H[0] \\ H[1] \\ \vdots \\ H[K-1] \end{bmatrix} + \begin{bmatrix} N[0] \\ N[1] \\ \vdots \\ N[K-1] \end{bmatrix} \quad (4)$$

The received signal vector can be expressed as Y , where, H represents the channel response vector, and N represents the noise vector, which has a mean value of: $E\{N[k]\}=0$ and variance of: $Var\{N[k]\}= \sigma_x^2$ [10].

II.5.1. Channel Interpolation

Interpolation or midpoint estimation is the process of determining the value that is somewhere between two known values. Due to the amount of bandwidth that the

pilot symbols will occupy as a result of being transmitted with the information block, the amount of pilots transmitted need to be reduced. The effect of interpolation on the channel involves the estimation of the channel at the placement point of the pilot symbols which is the point of missing data and can be achieved by comparing the information of estimates of the neighboring channels. Simply put, the estimated points where the subcarriers of the data symbols should be inserted can be derived by the interpolation of adjacent pilot symbols. Interpolation can be achieved by various means and they include, second order polynomial interpolation, piecewise constant interpolation, FFT based interpolation, Spline interpolation and Linear interpolation. Linear interpolation provides a very simple way to determine the pilot data that is somewhere between two known successive pilot subcarriers [22], [23].

Equation (5) gives the impulse response of the estimate of a channel's subcarrier system, $k, mL \leq k < (m+1)L$, using linear interpolation:

$$\begin{aligned} \hat{H}(k) &= \hat{H}(mL+l) = \\ &= \left(1 - \frac{l}{L}\right) \hat{H}_P(m) + \frac{l}{L} \hat{H}_P(m+1) = \\ &= \hat{H}_P(m) + \frac{l}{L} (\hat{H}_P(m+1) - \hat{H}_P(m)), 0 \leq l < L \end{aligned} \quad (5)$$

When Spline interpolation is considered, the Spline function is used to implement third order or cubic Spline interpolation at different data points by placing a unique cubic function between pairs of existing data points. FFT interpolation technique works by first transforming the signal which is in form of a vector containing periodic function, increasing the points on the system and finding the IFFT of the increased data point. A sizeable number of pilots are required when transmitting for channel estimation in order to achieve channel frequency spectrum. The channel estimates of the data subcarriers are obtained using interpolation technique. This places a very high emphasis on interpolation.

III. Methodology

The simulation parameters and the system initialization parameters are shown in Table I.

TABLE I
SYSTEM SIMULATION PARAMETERS AND VALUES

System Parameters	Value
Simulation runs	1000000
Data Length	128
Frame Length	64 for QPSK
SNR Values in (db)	0-30
Channel Type	Multipath Channel
Number of Channel Taps	5
Cyclic Prefix	10
Pilot Data Ratio	1:1, 1:3, 1:7, and 1:15
Modulation Techniques	QPSK
Antenna Configurations	SISO, MISO (2X1)

IV. Result and Analysis

IV.1. Comparison of the Various Interpolation Techniques

In order to find the optimal interpolation technique, comparisons were made between the techniques based on BER and SNR.

Figure 6 shows the BER versus SNR for the various interpolation techniques. As shown in the diagram, the FFT technique provides the best interpolation performance.

Next to the FFT technique is the Spline technique, then, the piecewise (cubic) technique and lastly, the linear interpolation. The FFT interpolation technique compared to the others also shows the least complexity.

The BER curve for the FFT provides a near to perfect estimate of channel when compared to the characteristics of the block type.

This shows that FFT gives the optimum channel estimation with efficient energy utilization and reduced complexity.

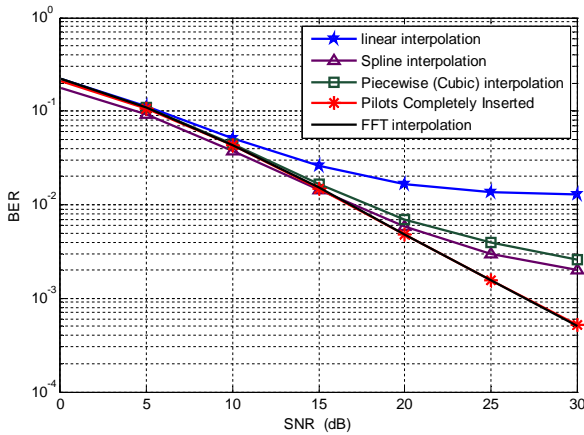

Fig. 6. Channel Estimation Techniques and their comparisons

IV.2. Block Pilot Type and Comb Pilot Type Channel Estimation

Figure 7 shows that MMSE outperforms the LS giving an SNR gain of 10-15 dB, with same MSE and pilot ratios. The good performance of the MMSE is at the cost of high system complexity and power consumption. The complexity of the system in turn leads to increased mathematical computations than what is obtainable with the LS estimate. The more the mathematical operation performed, the higher the execution cycle when the system is simulated, which also increases the systems power consumption.

Figure 7 also shows the BER versus SNR for the block type arrangement. Here, the pilots are placed in all the subcarriers at regular intervals of time. The result shows that the block pilot has an enhanced performance with the basic assumption that the channel is slow fading (i.e. it doesn't change during the OFDM symbol duration).

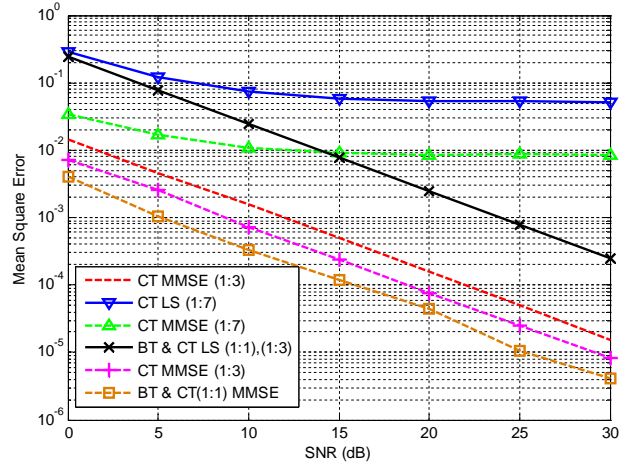

Fig. 7. Block Pilot Type and Comb Pilot Type Channel Estimation

Implementing the comb type estimation requires interpolation in the time domain to obtain the estimates at intervals where pilots are not inserted. This affects the accuracy when considering the total number of pilots used. Considering the LS and MMSE channel estimation, when a pilot-data ratio of 1:7 is used (i.e inserting 8 pilots), a poor system performance was observed even when the SNR values were increased, compared to the results obtained with a 16 and 32 pilot (i.e. a pilot-data ratio of 1:3 and 1:1 respectively). When similar pilot ratio is used for the LS estimation, the performance of the system is still in the acceptable limits shown by the “black line” on the graph. In summary, it can be deduced that system performance begins to deteriorate with decrease in number of pilots.

IV.3. Comparison of the BER with and without OFDM, for SISO Channel Estimation

This comparison shows the relevance of OFDM technique in channel estimation, to reduce the effect of ISI in the communication channel. This is achieved by comparing the LS and MMSE channel estimation when OFDM technique is applied and when it is not. The result obtained is presented by the graph in Figure 8 which shows that increasing the SNR, decreases the BER, giving a better performance with OFDM, but without OFDM, the performance depreciates with further increase in SNR above 15 dB. This came about when the high-power subcarrier signals interfering with the main channel are not orthogonal to each other causing ISI in the overall system.

With all the observations made above, it can be concluded that the OFDM is the most effective and preferred tool in battling the inter symbol interference (ISI) in channel estimation.

IV.4. Comparing Channel Estimation for MISO and SISO Using BER as Performance Metric

The comparison in Figure 9 shows how increasing the

number of transmit antennas (MISO), can actually improve the system performance. Using a BER threshold of 10^{-3} , a gain of about 13 dB was observed in the MISO channel estimation than the SISO when LS and MMSE are considered. It is also noticed that when the values of SNR begin to go up, the rate at which the MMSE BER system performance improves is greater than that of the LS. Furthermore, the BER performance for the SISO MMSE outperformed the SISO LS by a gain of about 2.5 dB, while a BER performance of 5dB was experienced when the MISO MMSE and the MISO LS were compared.

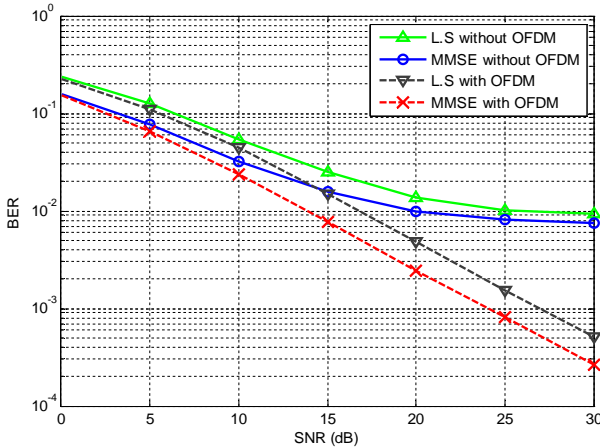

Fig. 8. SISO Channel Estimation with and without OFDM using BER as a Performance Metric

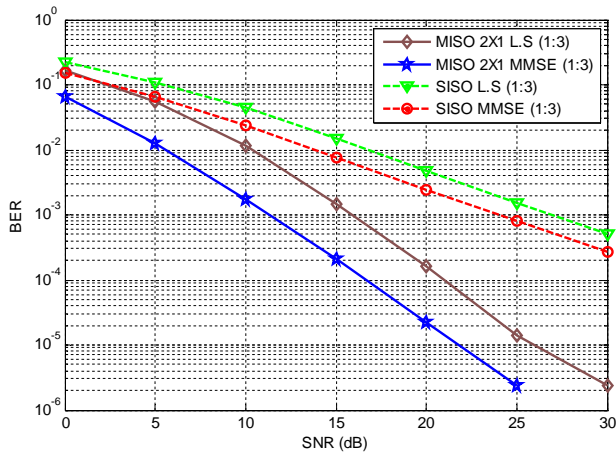

Fig. 9. MISO and SISO Channel Estimation Comparison

IV.5. Comparison for MISO LS Channel Estimation Using BER as Performance Metric Alongside Varying Pilot-Data Ratio

Figure 10 is used to describe the comparison of the BER value of the MISO LS channel estimation considering various pilot-data ratio.

As observed from the graph, using a pilot-data ratio of 1:1 and 1:3 are used, would suffice for accurate interpolation of the pilot data to give a desirable channel estimate.

But when the pilot ratio is reduced, (i.e. 1:7 and 1:15), errors in the channel estimates due to the reduction in the data available for interpolation were experienced, even with increase in SNR. Therefore, using a pilot-data ratio of 1:7 and 1:15 are insufficient to effectively interpolate the LS channel correctly. The same observation was made with the SISO system.

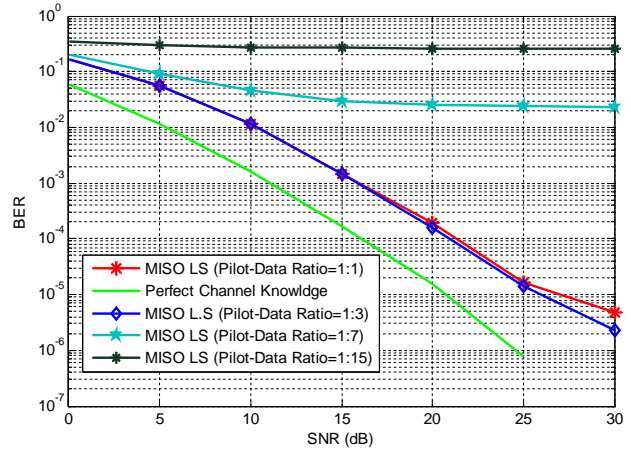

Fig. 10. MISO Channel Estimation BER Comparison with different Pilot-Data Ratio

V. Conclusion

The block type pilot arrangements, comb type pilot arrangements, the LS and MMSE channel estimation technique using MISO and SISO, with and without OFDM, have been modelled, simulated and compared, and conclusions have been made.

The FFT has the best interpolation performance, followed by the spline, piecewise and linear.

The MMSE is more resistant to noise, and outperforms the LS, with 10-15dB gain in SNR. The LS requires a high SNR to match the MMSE's performance.

The good performance of the MMSE is achieved at the cost of complexity in the system, unlike the LS which is simple and less complex. Comparing the LS and MMSE using different pilot-data ratios, the LS, has an optimum pilot-data ratio of 1:3, while the MMSE has 1:7 because it minimizes the errors. Therefore the MMSE has a better spectral/bandwidth efficiency compared to the LS.

Combining the various techniques with the OFDM plays a vital role in utilizing bandwidth and combating interference thereby improving systems performance.

Increasing the number of antennas, improves the performance of the system, as observed in the MISO system outperforming the SISO system.

These various techniques can be combined in different ways, depending on the requirements of the system.

Acknowledgements

This paper is sponsored by Covenant University, Ota, Ogun State, Nigeria.

References

- [1] A. Sibille, C. Oestges, and A. Zanella, "MIMO from Theory to Implementation," Academy Press, Burlington, USA, 2011.
- [2] S. Yatawatta, A. P. Petropulu, and C. J. Graff, "Energy-Efficient Channel Estimation in MIMO Systems," *EURASIP Journal on Wireless Communications and Networking*, vol. Article ID 27694, pp. 1–11, 2006.
- [3] Y. S. Cho et al, "MIMO-OFDM Wireless Communications with MATLAB," IEEE Press, John Wiley and Sons (Asia) Pte Ltd. 2010.
- [4] K. Kwak et al, "New OFDM Channel Estimation with Dual-ICI Cancellation in Highly Mobile Channel," *IEEE Trans. Wireless Communications*, vol. 9, no. 10, p. 3156, Oct. 2010 .
- [5] H. Yang, "A road to future broadband wireless access: MIMO-OFDM based air interface", *IEEE Commun. Mag.*, vol. 43, no. 1, pp. 53-60, Jan. 2005.
- [6] H. Sampath, et al, "A fourth-generation MIMO-OFDM broadband wireless system: design, performance and Field trial results", *IEEE Communications Magazine*, No. 9, pp. 143-149, Sep. 2002.
- [7] K.-L. Du and M. N. S. Swamy, "Wireless Communication Systems", Cambridge University Press, New York, 2010.
- [8] A. Ghosh, D. R. Wolter, J. G. Andrews and R. Chen, "Broadband wireless access with WiMax/802.16: current performance bench marks and future potential", *IEEE communications magazine*, vol. 43, pp. 129-136, 2005.
- [9] D. Gesbert, M. Shafi, S. D. Shan, P. J. Smith and A. Naguib, "From theory to practice: an overview of MIMO space-time coded wireless systems", *IEEE Journal on Selected Areas in communications*, vol. 21, pp. 281-302, 2003.
- [10] Ashu Taneja "Review On Channel Estimation for MIMO-OFDM System Payal Arora" *International Journal of Future Generation Communication and Networking* Vol. 9, No. 5, pp. 189-196, 2016.
- [11] Z. Wu, "MIMO-OFDM Communication Systems: Channel Estimation and Wireless Location", PhD Dissertation, Electrical and Computer Engr., Louisiana State University and Agricultural and Mechanical College, May 2006.
- [12] Lizhong Zheng, and David N. C. Tse, "Diversity and Multiplexing: A Fundamental Tradeoff in Multiple-Antenna Channels," *IEEE Transactions on Information Theory*, Vol. 49, No. 5, May 2003.
- [13] S. Coleri, M. Ergen, A. Puri, and A. Bahai, "Channel Estimation Techniques Based on Pilot Arrangement in OFDM Systems" *IEEE Trans. Broadcasting*, vol. 48, no. 3, pp 223-229, Sept. 2002.
- [14] J. Rinne and M. Renfors, "Pilot spacing in orthogonal frequency division multiplexing systems on practical channels," *IEEE Trans. Consumer Electronics*, vol. 42, no. 4, Nov. 1996.
- [15] M. H. Hsieh and C. H. Wei, "Channel Estimation for OFDM Systems Based on Comb-Type Pilot Arrangement in Frequency Selective Fading Channels" *IEEE Trans. Consumer Electronics*, vol. 44, no. 1, pp. 217-225, Feb. 1998.
- [16] J Okokpujie, K., Chukwu, E., Noma-Osaghae, E., Okokpujie, I., Novel Active Queue Management Scheme for Routers in Wireless Networks, (2018) *International Journal on Communications Antenna and Propagation (IRECAP)*, 8 (1), pp. 52-61.
doi:https://doi.org/10.15866/irecap.v8i1.13408
- [17] Etinosa Noma Osaghae, Kennedy Okokpujie, Charles Ndujiuba, Olatunji Okesola, Imhade P. Okokpujie, Epidemic Alert System: A Web-based Grassroots Model. *International Journal of Electrical and Computer Engineering (IJECE)* 8, no. 5 (2018). <http://www.iaescore.com/journals/index.php/IJECE/article/view/9007>
- [18] Kennedy Okokpujie, Olamilekan Shobayo, Etinosa Noma-Osaghae, Okokpujie Imhade, Obinna Okoyeigbo, Realization of MPLS-Based VPN Network for Improved Qos Metrics. *TELKOMNIKA (Telecommunication Computing Electronics and Control)* 16, no. 5 (2018). <http://journal.uad.ac.id/index.php/TELKOMNIKA/article/view/7326>.
- [19] Okokpujie Kennedy O., Okoyeigbo Obinna, Okhaifoh J.E., Omoruyi Osemwegie, Nsikan Nkordeh. "Performance Analysis and Modeling of MIMO Systems" *International Journal of Applied Engineering Research* Vol. 11, Number 23, pp. 11537-11541, 2016.
- [20] O. Okoyeigbo, K. Okokpujie, O. Omoruyi, N. Nkordeh "Comparative Analysis of Channel Estimation Techniques in SISO, MISO and MIMO Systems," *International Journal of Electronics and Telecommunications* 2017, Vol. 63, NO. 3, PP. 299-304, 2017.
- [21] Kota, P., Gaikwad, A., Analysis of Detection Methods for Space Frequency Block Code MIMO-OFDM System in Fast Fading Channels, (2017) *International Journal on Communications Antenna and Propagation (IRECAP)*, 7 (7), pp. 635-640.
doi:https://doi.org/10.15866/irecap.v7i7.13613
- [22] Agboje, O., Idowu-Bismark, O., Ibhaze, A., Comparative Analysis of Fast Fourier Transform and Discrete Wavelet Transform Based MIMO-OFDM, (2017) *International Journal on Communications Antenna and Propagation (IRECAP)*, 7 (2), pp. 168-175.
doi:https://doi.org/10.15866/irecap.v7i2.10803
- [23] Kota, P., Gaikwad, A., Fireflies Algorithm Based Optimal Scrambling to Reduce PAPR in SFBC Based MIMO-OFDM, (2017) *International Journal on Communications Antenna and Propagation (IRECAP)*, 7 (7), pp. 626-634.
doi:https://doi.org/10.15866/irecap.v7i7.13567
- [24] Okokpujie, K., Chukwu, E., Noma-Osaghae, E., Okokpujie, I., Novel Active Queue Management Scheme for Routers in Wireless Networks, (2018) *International Journal on Communications Antenna and Propagation (IRECAP)*, 8 (1), pp. 52-61.
doi:https://doi.org/10.15866/irecap.v8i1.13408
- [25] Amhaimar, L., Ahyoud, S., Asselman, A., An Efficient Combined Scheme of Proposed PAPR Reduction Approach and Digital Predistortion in MIMO-OFDM Systems, (2017) *International Journal on Communications Antenna and Propagation (IRECAP)*, 7 (5), pp. 378-385.
doi:https://doi.org/10.15866/irecap.v7i5.11190

Authors' information

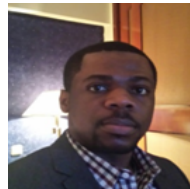

Obinna Okoyeigbo has a Bachelors Degree in Electronic Engineering, and an MSc. in Communications Engineering, from The University of Manchester. He is a member of The Nigerian Society of Engineers, and a Registered Engineer with COREN. He has previously worked with Alcatel-Lucent, and is currently involved in research and lecturing at Covenant University. His research interests include; Next Generation Communication Systems 5G & Beyond, IoT, Channel Estimation, MIMO etc. He can be reached by email: obinna.okoyeigbo@covenantuniversity.edu.ng



Kennedy Okokpujie holds a Bachelor of Engineering (B.Eng.) in Electrical and Electronics Engineering, Master of Science (M.Sc.) in Electrical and Electronics Engineering, Master of Engineering (M.Eng.) in Electronics and Telecommunication Engineering and Master of Business Administration (MBA). He is currently on his Ph.D in Information and Communication Engineering/ Lecturing with the Department of Electrical and Information Engineering at Covenant University, Ota, Ogun State, Nigeria. He is a member of the Nigeria Society of Engineers and the Institute of Electrical and Electronic Engineers (IEEE). His research areas of interest include Biometrics, Wireless Communication and Digital signal Processing. Contact him at: kennedy.okokpujie@covenantuniversity.edu.ng



Dr. C. U. Ndujiuba holds a PhD in Electrical & Electronics Engineering from the University College London (University of London); Mastere Specialise (Masters with Specialisation)in Radio Communications from Ecole Superieure d'Electricite (SUPELEC) France; MSc in Electrical Engineering from the University of Lagos; BSc in Electronics &

Communications Engineering from the London Metropolitan University. Dr. Ndujiuba is a Chartered Electronics Engineer (CEng) and a highly skilled wireless professional. He has more than 25 years RF, Microwave, Fixed-line (SDH and PDH), and PMR experience, with considerable international exposure. Dr. Ndujiuba has attended several conferences and published many technical papers in major professional journals. Prior to joining Covenant University Ota Nigeria in 2011, Dr. Ndujiuba was the Technical Director of Globe Trunk Ltd UK. His research interests include: Monolithic Microwave Integrated Circuits (MMIC), Active Filters, Ultra-Low Noise Amplifiers, Active Devices and Circuits, UWB Transmitter, Modelling & Simulation, Dielectric Resonator Antennas and Detection and Collision Avoidance of Unmanned Aerial Vehicles.



Etinosa Noma-Osaghae is with the Department of Electrical and Information Engineering at Covenant University, Ota, Ogun State, Nigeria. He has a master's degree in Electronic and Telecommunication. Information Theory, Digital Signal Processing and Wireless Communication are his research areas of interest.

E-mail: etinosa.noma-osaghae@covenantuniversity.edu.ng



Shobayo Olamilekan had his first degree in Electrical and Computer Engineering from Federal University of Technology Minna, Nigeria in 2011. He later proceeded for his second degree in Computer and Networks Engineering from Sheffield Hallam University, UK in 2016. He has worked as Network Infrastructure Engineer at the National Institute

of Information Technology (NIIT). He has also worked as a Lecturer and researcher in Covenant University Ota Nigeria, we he lectured Computer architecture, Networking and C programming. He his CCNA and CCNP certified and has vast experience in programming with the C language.