

PAPER • OPEN ACCESS

## Design and construction of a home air quality monitoring system

To cite this article: S. Ochie *et al* 2022 *IOP Conf. Ser.: Earth Environ. Sci.* **993** 012022

View the [article online](#) for updates and enhancements.

### You may also like

- [Review of the application of energy harvesting in buildings](#)  
J W Matiko, N J Grabham, S P Beeby et al.
- [Study on the Purification Effect of Clean Fresh Air on PM2.5 in the Bedroom](#)  
Qian Yuan and Guojian Li
- [Viability of residential properties in Ota, Ogun state Nigeria using modified break-even valuation technique](#)  
C. O. Iroham, S. A. Oni, H. I. Okagbue et al.



The Electrochemical Society  
Advancing solid state & electrochemical science & technology

242nd ECS Meeting

Oct 9 – 13, 2022 • Atlanta, GA, US

**Extended abstract submission deadline: April 22, 2022**

Connect. Engage. Champion. Empower. Accelerate.

**MOVE SCIENCE FORWARD**



Submit your abstract



# Design and construction of a home air quality monitoring system

**S. Ochie, M.R. Usikalu, A. Akinpelu\*, W.A. Ayara and O.W. Ayanbisi**

Department of Physics, Covenant University, Ota, Nigeria

S. Ochie's Email: samuel.ochie@stu.edu.ng

M.R. Usikalu's Email: moji.usikalu@covenantuniversity.edu.ng; ORCID: 0000-0003-2233-4055

A. Akinpelu's Email: akinwumi.akinpelu@covenantuniversity.edu.ng; ORCID: 0000-0003-4149-9680

W.A. Ayara's Email: williams.ayara@covenantuniversity.edu.ng; ORCID: 0000-0001-5782-616X

O.W. Ayanbisi's Email: oluwasegun.ayanbisi@covenantuniversity.edu.ng

\*Corresponding email: akinwumi.akinpelu@covenantuniversity.edu.ng

**Abstract:** Air pollution is one of the most dangerous problems we face in the world today. It is the cause of many illnesses like asthma, cancer, bronchitis, congenital disabilities and other diseases that affect the immune system of both humans and non-human animals. Among the factors that characterize the quality of air are temperature and humidity and the level of Carbon dioxide in the environment. This research involves the design and construction of a device that measures the temperature, humidity and  $CO_2$  levels in an environment, using a DHT11 and MQ135 sensor. The values were compared with the expected values from a trusted website to determine the accuracy of the device. The device was also used to take the temperature, humidity and  $CO_2$  levels of the living room, bedroom, kitchen and balcony in a house to determine the quality of air in the house. The results obtained in the living room and balcony revealed impressive air quality with the temperature and humidity in the safe zone while the level of  $CO_2$  was normal. The air quality in the bedroom was acceptable, although it could do with better ventilation if it is to house more people. The kitchen, however, showed high temperatures at certain hours and high humidity as well as  $CO_2$  levels. It was concluded that improvements are necessary for the ventilation of the kitchen to improve the quality of air.

**Keywords:** Carbon dioxide, Temperature, Humidity, Air quality.

## 1. Introduction

Air is an essential element necessary for all living things to survive, and pure air is necessary for a healthy life[1]. The quality of air is crucial as impurities could cause poor air quality in the atmosphere and, once inhaled by humans, could have very adverse effects ranging from tuberculosis to lung cancer [citations]. One of the many challenges that contribute to poor quality of air includes over population, which is a significant issue in Lagos state as too many



people are confined in a small space [2]. Even though Lagos state has a large surface area, about 452.23 square miles (1,171.28 square kilometres), the population is quite vast, currently housing over 17 million inhabitants [3]. As a result, it has a population density of about 17,800 residents per square mile (6,871 per square kilometre), and it keeps snow balling (World Population Review/ Lagos Population, 2019) these statistics is not only Lagos but Nigeria as a country

With the air quality in the atmosphere getting worse as a result of industrial, automobile, and agricultural animal pollution, there is an increasing risk of danger to living things, like lung cancer in humans[4,5] To find ways to eradicate this issue, first, a method of recognizing the problem by determining the origins must be implemented before going after them. Carrying this out requires monitoring the air quality in a controlled environment and comparing it with the healthy condition to assess the level of deviation. This air quality monitoring system can be applied to perform this task[6-8]. Therefore, this research aims to understand the significant factors that denote the air-quality of an environment and to design and construct a device that measures the parameters in order to denote the air quality in our environment using Arduino

The first section tells about the background of the study and the problem that it tries to solve. The second section lists the methodology, the components used to build the device and the design of the research and the process used in assembling the hardware components and the software module. The third section presents the results carried out by the device during the study and their interpretation which is used to determine the air quality of the house. The fifth section concludes the work and outlines recommendation on improving the air quality of the rooms measured as well as a guide to possible researches.

## **2. Methodology**

This section outlines the design and construction, and the components used. The parts will be assembled and placed inside the room and on the roof of the house, to determine the room temperature, humidity, and  $CO_2$  levels using the various sensors, and the values will be displayed through LCD and an external Bluetooth device. The device will be set up to take the environmental data, which will then be compared to a base standard value to determine accuracy.

## 2.1 Design and Construction

This air quality monitoring system uses two sensors, a temperature-humidity sensor, and a gas sensor, to generate the required data from the environment. The data obtained from the sensors are sent to an external bluetooth device using a bluetooth module with the operation being directed by a micro-controller. The values are also displayed on a LCD. A regulated power supply circuit converting the AC power supply to regulated DC power supply which consists of a step-down transformer, a bridge rectifier and a voltage regulator, is set up.

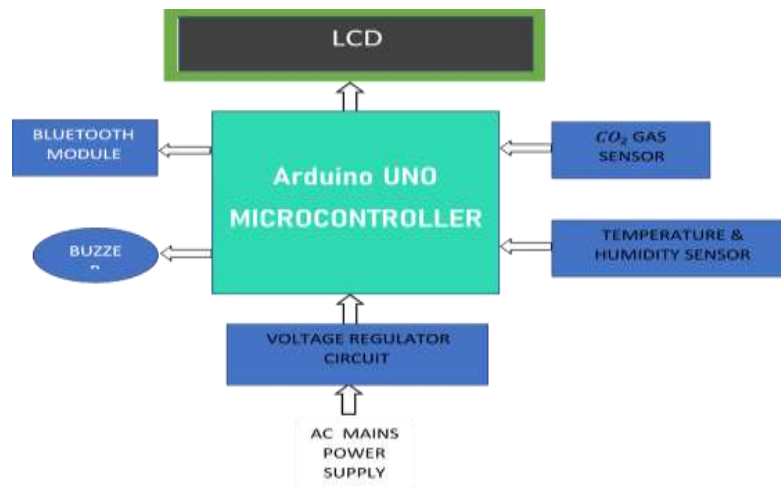

Figure 1: Block Diagram of the Proposed System

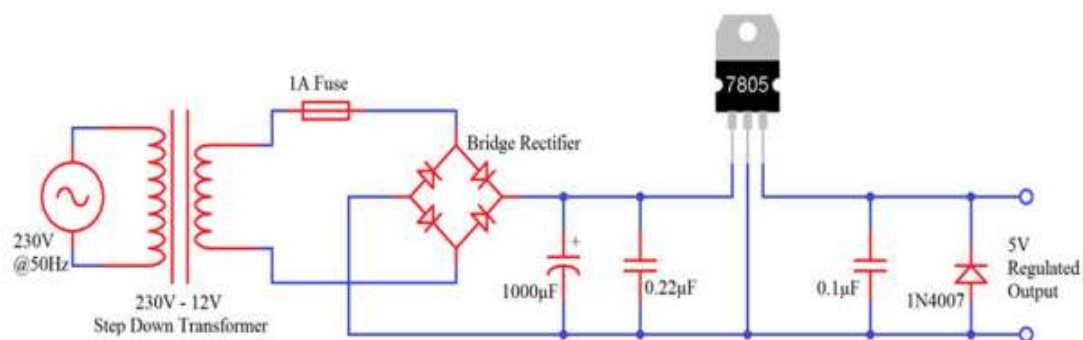

Figure 2: Power Supply Circuit Diagram (Source: [electronicshubs.org](http://www.electronicshubs.org))

## 2.2 Power Supply

The process can be divided into two sections. In the first section, the 230V AC Mains supply is converted into unregulated 12V DC, and in the second section, this unregulated 12V DC

supply is converted into regulated 5V DC. A 230V to 12V Step-down transformer is used to step down the voltage, by connecting its primary to the mains power supply. The secondary of the transformer is connected to Bridge rectifier, which outputs the 12V unregulated voltage.

The circuit limits the current drawn to 1A, and a 1A fuse is positioned between the transformer and the bridge rectifier. A 1000 $\mu$ F capacitor now smoothens out the rectified DC voltage from the bridge rectifier. At this point, the output across the 1000 $\mu$ F capacitor is an unregulated 12V DC, which then flows into the 7805 Voltage Regulator IC. The 7805 IC now converts this voltage to a regulated 5V DC supply which is obtained through its output terminals. The power supply from the voltage regulation circuit is connected to the Arduino with negative terminal (Cathode) connected to the ground pin of the Arduino, and the positive terminal (Anode) is connected to the Vin Pin. The Arduino dissipates power to the components through the ground pin as the cathode and the 5V pin as the anode. LCD Pin 1- Ground, LCD Pin 5- RW, LCD Pin 16- Led, DHT11 Pin 4-Ground, MQ135 Pin 2- Ground, HC-05 Pin 3- Ground and Buzzer Pin 2 were connected to the Arduino while the following pins were connected to the 5V pin of the Arduino: LCD Pin 2- Vcc, LCD Pin 15- Led+, DHT11 Pin 1-VDD, MQ135 Pin 1- VDD and HC-05 Pin 2- Vcc

### **2.3 Analogue to Digital Conversion and Sensor Interface**

Arduino has six distinct Analog to digital conversion pins. These pins are used to connect to the six different Analog output product sensors. They are labelled: A0, A1, A2, A3, A4, A5. The outputs from the Sensors are Analog values varying from 0 to 1023. These values are converted into binary format because the Arduino controller only supports the machine level language. The binary value of 0 to 1023 is considered as an output voltage varying from 0 to 5V. Digital Sensors are interfaced to the digital pins because they cannot interface analogue pins. As aforementioned, there are two different sensors used in this research: Temperature and Humidity sensor and gas sensor. Both Sensors have three different Pinouts. They are labelled as VCC, GND and Vout. VCC and GND supply power to the Sensors, while VOUT is the output sensing value of the Sensor. The ADC on the Arduino is a 10-bit ADC meaning it can detect 1,024 ( $2^{10}$ ) discrete analogue levels.

The DHT11, LCD and HC-05 are connected to digital pins on the Arduino while the MQ135 is connected to an analogue pin. The table below shows the connection of the output/input pins of components to the Arduino pins.

## 2.4 Software Module

The software module is the aspect that instructs the Arduino to take the readings from the sensors and display them on the LCD and Bluetooth serial module. The process for the display of the values on the Bluetooth serial module is shown in Figure 3.

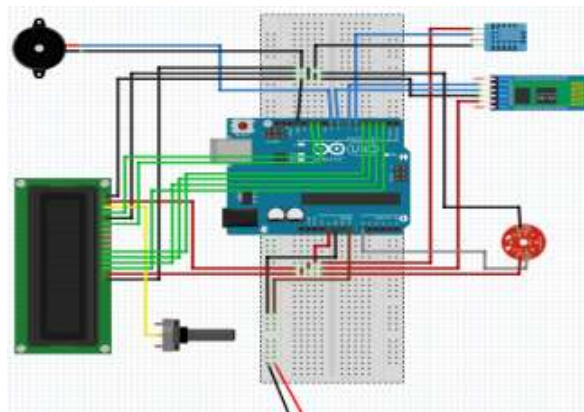

Figure 3: Circuit Simulation Diagram of the Research on a Bread-board

In the first process, the system includes the DHT11 temperature humidity sensor and LCD libraries and also defines the pins on which the DHT11 and MQ135 are connected on the Arduino board. In the next process, the variables of the Temperature, Humidity and air quality are declared as integer values. Next, the microcontroller starts accepting data from the sensors, the values of the temperature and humidity are read from the digital pin of the Arduino to which the DHT11 is connected, and the air quality value (Carbon dioxide) value is read from the analogue pin in which the MQ135 is connected. For the LCD, the Arduino sets the system to its initial values, then displays the values from the sensors. It waits for 6000 milliseconds, and it repeats the process. For the Bluetooth serial module, the device waits for the user to make an input corresponding to the parameter they need. For temperature, an input of 't' is required, for humidity, an input of 'h' is required and for  $CO_2$ , an input of 'a' is required, and if an input other than 't', 'h', or 'a' is entered, the device returns that input as the output.

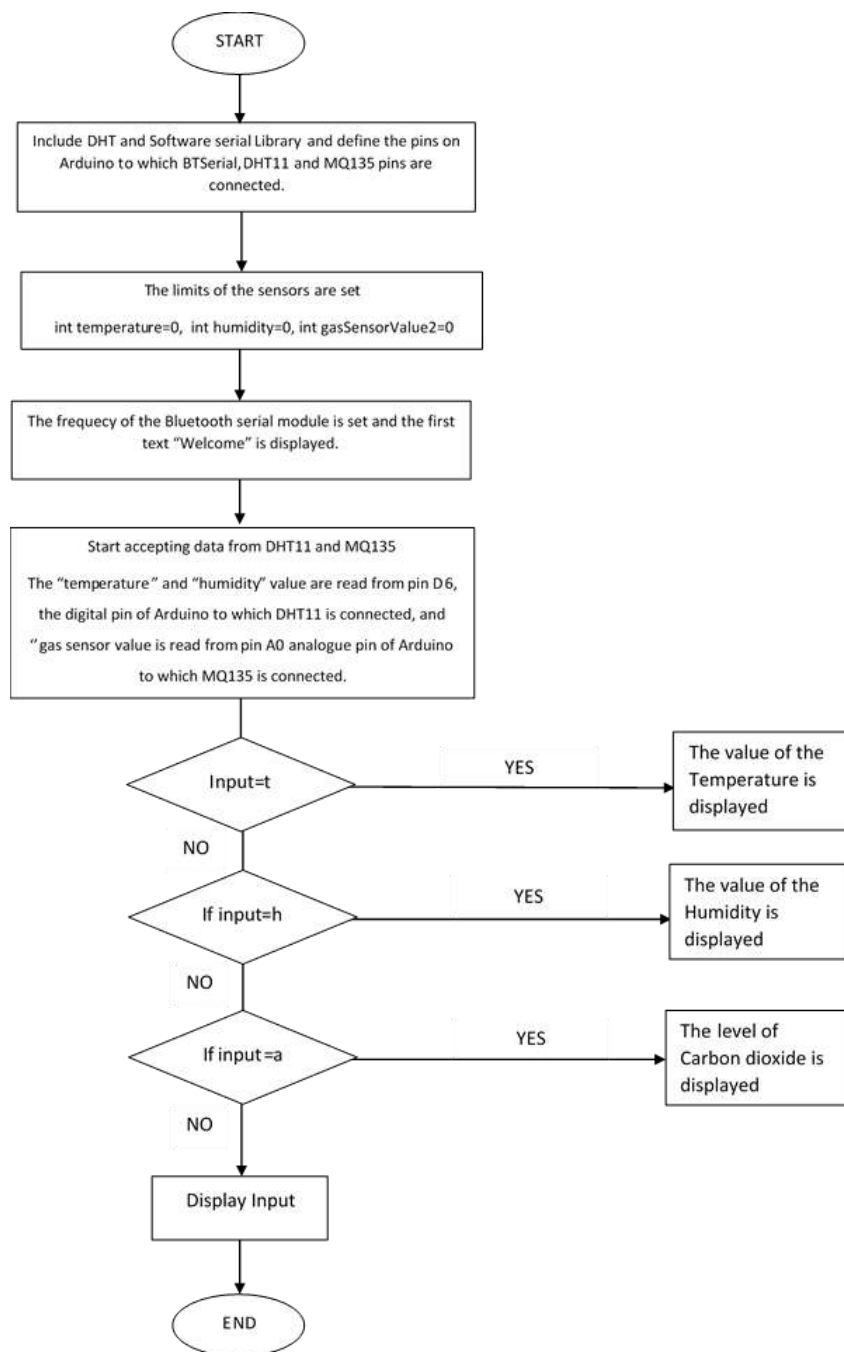

Figure 4: Flowchart for Displaying the Values on an LCD

The first part asks the computer to include the various libraries which would be used in the code. Next, it declares which pins on the Arduino board, the sensors are connected to, so that the microcontroller can read the values as input from the corresponding pins. The next part of

the code sets the cursor of the LCD to line 0 and column 0, operating frequency and the first display message of the output components (LCD, Bluetooth Terminal and Buzzer). The third part of the codes asks the microcontroller to read the analogues values from the sensors for the pins that have been assigned in the first part and send these readings as digital values to the module.

The fourth part of the codes asks the Arduino to display the digital values from the sensors on the LCD and send it to the Bluetooth serial module so that it can be displayed on an external device. The final part of the code programs the buzzer to sound at different intervals for various conditions when the sensors are reading values indicating abnormal Humidity, Temperature or level of Carbon dioxide in the environment.

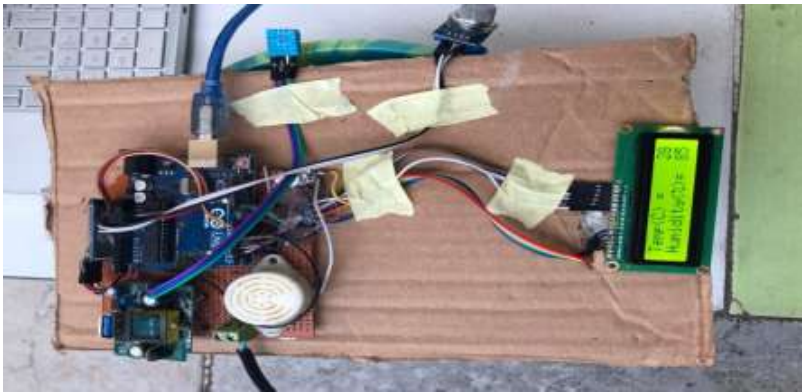

Figure 5: Picture of constructed device showing temperature and humidity readings.



Figure 6: Picture of constructed device showing Carbon dioxide readings.



### 3. Results and discussion

In order to ensure that the device is accurate, it is placed on a free platform and used to measure the temperature, humidity and level of carbon dioxide in the atmosphere over 13 hours. These values are compared with the values released by a trusted website-[www.accuweather.com](http://www.accuweather.com) for lagos state. The data from [www.accuweather.com](http://www.accuweather.com) and the air quality monitoring device for the atmospheric temperature and humidity in Lagos state on 7 August 2020 from 9:00 am to 9:00 pm are presented in Table 1.

Table 1: Temperature and Humidity in Lagos state on the from 9:00 am to 9:00 pm

Time	<i>Temperature (<math>^{\circ}C</math>)</i>		<i>Humidity (%)</i>	
	System Data	Website Data (Accuweather)	System Data	Website Data (Accuweather)
09:00	27	25	77	78
10:00	28	26	72	74
11:00	29	26	73	70
12:00	28	27	67	69
13:00	28	28	68	68
14:00	29	28	67	67
15:00	31	29	70	68
16:00	27	27	70	69
17:00	27	27	73	71
18:00	23	25	77	74
19:00	27	26	80	76
20:00	27	27	77	79
21:00	26	26	79	81

The data collated is represented in the graph in Figure 7 to show a diagrammatic comparison of the values. From the graph, there are some differences, but they are quite negligible, especially in this aspect of science. Therefore the device has an acceptable level of accuracy.

**3.1 Air Quality Monitoring:** The air quality monitoring device was used to collect data from three different rooms and the balcony of a house in order to compare the Temperature, Humidity and level of  $CO_2$  in these rooms, in order to determine the quality of air in the house.

**3.2 Living Room:** The living room of the house is the first location of the house. This room measures approximately 35ft by 50ft by 12ft and has three big windows; as a result, the room is adequately spaced and ventilated. The values for the temperature, humidity and  $CO_2$  are over 13 hours are presented in Table2.

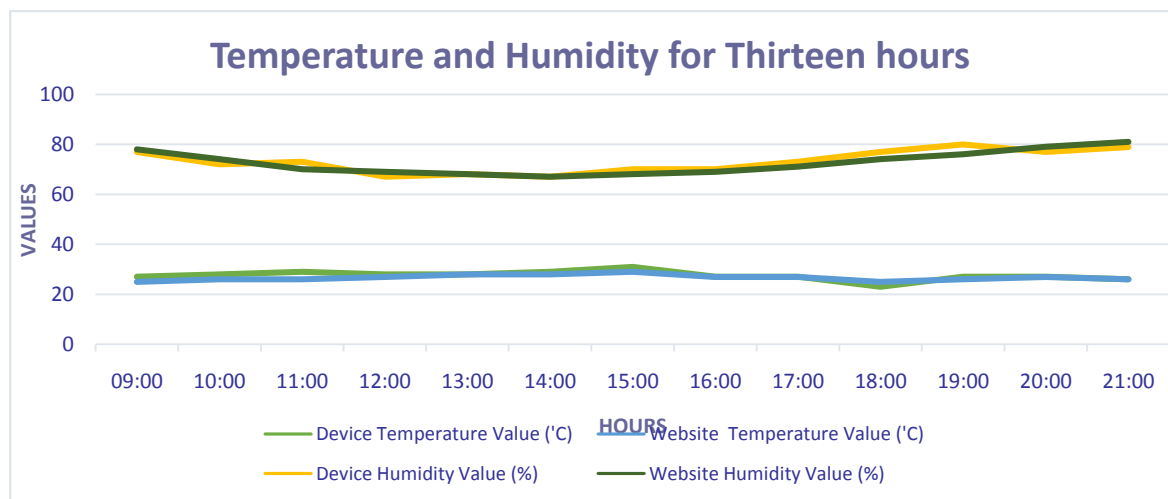

Figure 7: Graph showing the comparison between the values measured by the air quality monitoring device and the data from accuweather.com

Table 2: Temperature, humidity and carbon dioxide values for living room.

Time	Temperature (°C)	Humidity (%)	Carbon dioxide (ppm)
09:00	27	85	287
10:00	28	74	352
11:00	27	75	319
12:00	29	79	238
13:00	31	73	228
14:00	29	75	243
15:00	28	76	223

16:00	27	78	213
17:00	28	77	218
18:00	28	75	203
19:00	27	79	310
20:00	26	84	271
21:00	26	83	254

**3.3 Bedroom:** The bedroom is a much smaller room than the living room with two windows and not much space, though it has few furniture; as a result, it is relatively ventilated. The results collated by the air quality monitor over 13 hours are presented in Table3

Table 3: Temperature, Humidity and carbon dioxide values for bedroom.

Time	Temperature (°C)	Humidity(%)	Carbon dioxide (PPM)
09:00	26	80	387
10:00	27	74	352
11:00	27	70	319
12:00	28	69	410
13:00	29	67	387
14:00	28	69	543
15:00	28	69	260
16:00	28	70	363
17:00	27	72	418
18:00	27	75	503
19:00	26	79	310
20:00	26	81	271
21:00	26	82	254

**Kitchen:** The kitchen is quite smaller than the bedroom and the living room, and it has only one window. As a result, it is not as ventilated as the two previous rooms. Also, much heat is released into the surrounding during cooking and other activities. The values collated for the kitchen are presented in Table 4.

Table 4: Temperature, humidity and carbon dioxide values for kitchen.

Time	Temperature (°C)	Humidity (%)	Carbon dioxide (PPM)
09:00	31	61	548
10:00	30	68	777
11:00	29	75	533
12:00	30	75	430
13:00	29	73	678
14:00	29	74	524
15:00	30	66	997
16:00	31	60	438
17:00	34	53	903
18:00	32	57	1034
19:00	30	63	916
20:00	31	64	915.4
21:00	30	63	507

**Balcony:** This is an open space that overlooks the external atmosphere from the first floor; it is sufficiently spaced and ventilated. Table 5 presents the values for the balcony.

Table 5: Temperature, humidity and carbon dioxide values for balcony.

Time	Temperature (°C)	Humidity(%)	Carbon dioxide (PPM)
09:00	25	85	410
10:00	27	74	389
11:00	28	75	352
12:00	29	79	319
13:00	30	73	313
14:00	31	75	295
15:00	29	76	319
16:00	27	78	283
17:00	28	77	271
18:00	26	75	354
19:00	25	79	254

20:00	24	88	260
21:00	24	90	271

It was earlier discussed that the acceptable temperature range for good air quality is between 25–32 °C (World Health Organization, 2018) and the humidity range 35% and 65% (Bryson, 2019). The values which were measured from the rooms are compared with the acceptable ranges to determine the air quality. The graph in Figure 8 shows the comparison.

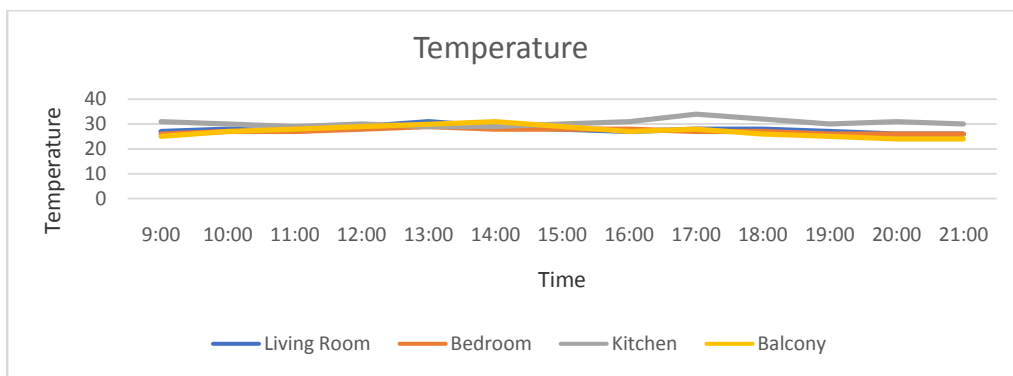

Figure 8: Graph of the Temperatures of the four rooms in the house.

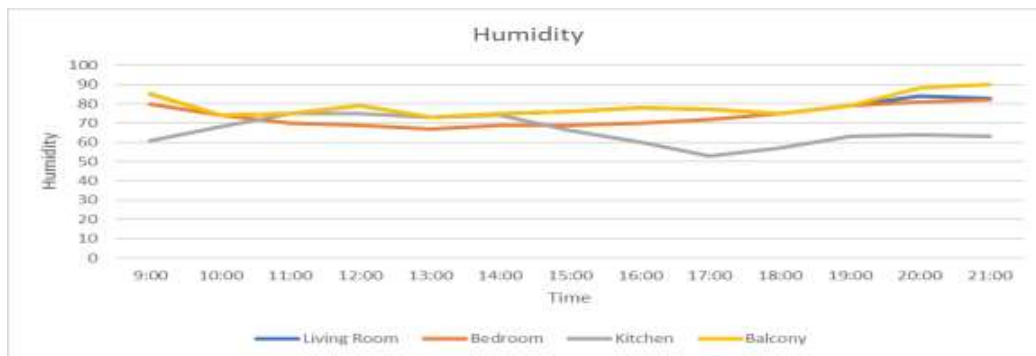

Figure 9: Graph of the Humidity of the four rooms in the house.

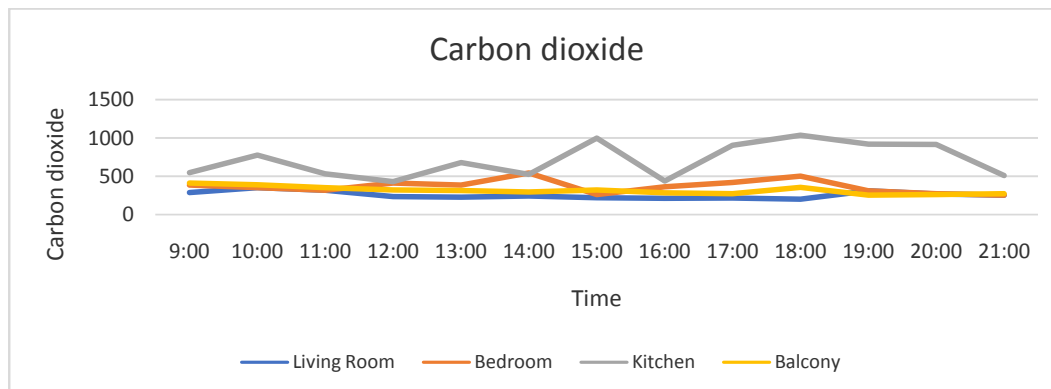

Figure 10: Graph of the Carbon dioxide of the four rooms in the house.

#### 4. Conclusion

A convenient system of monitoring the air quality in an environment efficiently but at a low cost is presented in this report. In the proposed architectural framework, functions of two sensors and their working procedure were discussed. Their working principle, functionalities and data taking procedures are discussed. The results gotten from the designed research is compared with standard base data are also discussed here. From the results gotten, the house can be said to have an acceptable level of air quality. Occupants in the living room, bedroom and balcony will rarely experience any discomfort as the temperature level is well within the acceptable limits. At the same time, the humidity while being quite high will rarely cause any problems at that temperature. The carbon dioxide levels are also healthy for the living room and balcony, while the bedroom would need some sort of improvement if more people are to reside in it, but for the current level of the population, it is good. The kitchen could see significant improvements in the air quality as it seems to get hot quite often, causing the high humidity levels to cause some noticeable discomfort. Also, the carbon dioxide levels in the kitchen area on the high side and some sort of cross ventilation could be put in place to improve the condition

#### REFERENCES

1. Ayara W. A, Omotosho T. V, Usikalu M. R, Singh M. S and Suparta W. (2017) Development of a solar charged laboratory bench power supply, *Journal of Physics: Conference Series*, **852(1)**: 012044

2. Usikalu M. R, Adebessin E. and Obafemi L. N (2019) Design and construction of backpack mobile charger, *ARPN Journal of Engineering and Applied Sciences*,**14(21)**: 3743 – 3746
3. Usikalu, M.R., Oyeniran, F.T., Ayara, W.A., Babarimisa, I.I., Obafemi, L.N. (2021) Construction of a Mobile Frequency Modulation Transmitter, IOP Conference Series: Earth and Environmental Science, 655(1), 012034
4. Usikalu, M.R., Isaac, E.G., Olawole, C.O., Abodunrin, T.J., Kayode, O.T. (2019) Design and construction of solar powered fabric dryer, *International Journal of Mechanical and Production Engineering Research and Development*, 9(6): 139–14
5. Barreca, A. I. (2012). Climate change, humidity, and mortality in the United States. *Journal of Environmental Economics and Management*, 63(1), 19--34.
6. Bryson. (2019). The effects of humidity on the human body(Achooallergy.com, Producer) Retrieved from theAchoo Allergy: <https://www.achooallergy.com/blog/learning/the-effects-of-humidity-on-the-human-body/>
7. Chakraborty, A. (2017). Airqualitysensingandmonitoring Doctoral Dissertation, West Bengal University of Technology, BELIAGHATA, KOLKATA. Retrieved from [https://www.rcciit.org/students\\_researchs/researchs/aeie/2018/GR1.pdf](https://www.rcciit.org/students_researchs/researchs/aeie/2018/GR1.pdf)
8. Humidity sensor,basics, usage, parameters and applications. (2019). Retrieved from Electronicsforu.com: <https://electronicsforu.com/resources/electronics-components/humidity-sensor-basic-usage-parameter>