

# DIGITALES ARCHIV

Alayande, Akintunde Samson; Owoicho, O. D.; Somefun, Tobiloba Emmanuel et al.

## Article

### Power quality considerations for distributed generation integration in the Nigerian distribution network using NEPLAN software

#### Provided in Cooperation with:

International Journal of Energy Economics and Policy (IJEPP)

*Reference:* Alayande, Akintunde Samson/Owoicho, O. D. et. al. (2021). Power quality considerations for distributed generation integration in the Nigerian distribution network using NEPLAN software. In: International Journal of Energy Economics and Policy 11 (5), S. 331 - 342.

<https://www.econjournals.com/index.php/ijeep/article/download/11145/6030>.

doi:10.32479/ijeep.11145.

This Version is available at:

<http://hdl.handle.net/11159/7847>

#### Kontakt/Contact

ZBW – Leibniz-Informationszentrum Wirtschaft/Leibniz Information Centre for Economics

Düsternbrooker Weg 120

24105 Kiel (Germany)

E-Mail: [rights\[at\]zbw.eu](mailto:rights[at]zbw.eu)

<https://www.zbw.eu/econis-archiv/>

#### Standard-Nutzungsbedingungen:

Dieses Dokument darf zu eigenen wissenschaftlichen Zwecken und zum Privatgebrauch gespeichert und kopiert werden. Sie dürfen dieses Dokument nicht für öffentliche oder kommerzielle Zwecke vervielfältigen, öffentlich ausstellen, aufführen, vertreiben oder anderweitig nutzen. Sofern für das Dokument eine Open-Content-Lizenz verwendet wurde, so gelten abweichend von diesen Nutzungsbedingungen die in der Lizenz gewährten Nutzungsrechte.

<https://zbw.eu/econis-archiv/termsfuse>

#### Terms of use:

*This document may be saved and copied for your personal and scholarly purposes. You are not to copy it for public or commercial purposes, to exhibit the document in public, to perform, distribute or otherwise use the document in public. If the document is made available under a Creative Commons Licence you may exercise further usage rights as specified in the licence.*



# Power Quality Considerations for Distributed Generation Integration in the Nigerian Distribution Network Using NEPLAN Software

Akintunde S. Alayande<sup>1</sup>, O. D. Owoicho<sup>1</sup>, Tobiloba Emmanuel Somefun<sup>2</sup>, Joseph Olowoleni<sup>2</sup>, Ignatius K. Okakwu<sup>3</sup>, Ademola Abdulkareem<sup>2</sup>

<sup>1</sup>University of Lagos, Lagos, Nigeria, <sup>2</sup>Covenant University, Nigeria, <sup>3</sup>Department of Electrical and Electronics Engineering, Olabisi Onabanjo University, Ago-Iwoye, Nigeria. \*Email: [tobi.shomefun@covenantuniversity.edu.ng](mailto:tobi.shomefun@covenantuniversity.edu.ng)

Received: 03 February 2021

Accepted: 24 May 2021

DOI: <https://doi.org/10.32479/ijeep.11145>

## ABSTRACT

Power quality studies are increasingly becoming a toast of major researchers as it is now a major factor utilized in determining the overall efficiency of an electrical power system. Voltage profile and power loss are significant pointers to the quality of power and as such, distributed generation comes into play since it offers competitive advantages over the traditional grid interconnected system. In this study, therefore, an attempt is made in comparing the voltage profile of the traditional grid system of a typical distribution network and with that incorporated with the distributed generation, using real data of a practical system of the Nigeria distribution company. The conceptual framework as well as the mathematical formulations required for the study are presented. The data are, then, simulated using a NEPLAN software. The results obtained from the simulations for power losses in both scenarios are examined. The results obtained clearly showed that there is a significant reduction in power losses and a substantial improvement in the voltage profile of an embedded generation in-feed scheme in comparison with the conventional grid in-feed.

**Keywords:** Distributed Generation, Power Quality, Voltage Profile, Grid in-feed, Transmission Losses

**JEL Classifications:** C63, L94, L98, Q48

## 1. INTRODUCTION

Power plants utilize transmission grid networks to transmit energy over long distance and in the process of transporting the generated power, some of it is lost (Sayed and Massoud, 2019). By introducing distributed generator within the network helps to minimise losses on the network (Jacxsens et al., 2011). Unlike the traditional model where, a loss in service at any point of the grid means implies a total shutdown of the whole system, distributed generation has proven to counter this major challenge as researched by authors of (Huy et al., 2020; Somefun et al., 2020). Some of the benefits offered by use of DG include improved power network stability, improvements in power quality, back-up power availability, etc. (Chiradeja, 2005).

In the present Nigeria grid, introduction DG is essential in the case of collapse of the grid due to various factors. Distributed Generation systems can help to guide against congestion due to peak demand on the network (Jenkins and Strbac, 1997; Zhao et al., 2013). However, this does not come without its attendant challenges which include location and size, system performance, short circuit power and fault current level, reverse power flow and voltage profile, reduced reach of impedance relay (Dulău et al., 2014; Zhao et al., 2013). Distributed generation offers the advantage of postponing major investment costs on the networks and also furthermore cutting down the transmission and distribution energy losses (Baghaee et al., 2016).

Conventional methods for achieving power quality involves application of shunt capacitor banks, load balancing among

three phases, deployment of FACTS devices, reconditioning of distribution lines and use of distribution energy storage (Sivaraman et al., 2017; Somefun et al., 2020). Switching of shunt capacitor usually pulls high frequency oscillatory currents from the circuit which produces over voltages and overcurrent's that can be damaging to its own components and other equipment that are connected within the same circuit (Shomefun et al., 2018). FACTS devices, though very useful for securing power systems in normal and unsteady state operations, can be very expensive to deploy. They are also subject to easy damage resulting from overheating in a case where the equipment draws too much power (Ahmad and Sirjani, 2019; Ghiasi, 2019). The undesirable effect of reconditioning of distribution lines is that it is very capital intensive and time consuming (Marszal-Pomianowska et al., 2020). Furthermore, proper sizing and placement of large-scale Distributed Energy Resources poses as a very enormous task (Li et al., 2020). However, incidences of overvoltages are totally eradicated in distributed generation, which in-turn minimizes overheating of conductors or damage to equipment. Due to the scalability nature of the distributed generation, cost is not a major factor for its deployment (Wang and Perera, 2019). Integrating distributed generation systems into medium voltage networks to a large extent eliminates or radically reduces these undesirable conditions presented by conventional approaches, thereby improving the overall efficiency of a given power system (Abdulkareem et al., 2020; Li et al., 2019; Ren et al., 2019).

Chiradeja (2005) through the line loss reduction analysis established that using Distributed Generation (DG) guides against losses within the network. He based this assertion on the fact that distributed Generation distributes a part of the required power to the load, hence reducing the incidence of under-voltage. The authors further established that though Distributed Generation may result in significant reduction in line loss, this is only as practicable as long as the rating of the DG and location are properly determined as corroborated by the authors of (Jamil and Anees, 2016; Navon et al., 2020). Nick et al. (2017) examined the effect of introducing several DGs on distribution network behaviour. The modelling captured an IEEE-13 bus distribution feeder which was fed by several Distributed generation sources. Multiple scenarios were simulated. The response of the system was monitored especially as regards to system's protection and unsymmetrical faults. To minimize the unwanted effect on distribution network with presence of DG in the event of faults, the study considered the flow of power in opposite direction with respect to integration of DG within power system network. The research also examined two types of SFCLPR and ICI after which justification were made. Tong et al. (2019) via a simulation verified the possibility of using a Distributed Generation Inverter's reminder capacity to considerably maintain the voltage profile to acceptable limits. One common issue with most Distributed generation is the flicker noise origin problem and (Bulatov et al., 2018) proposed an algorithm named look-ahead control. This algorithm aims to remove flicker noise and boost quality of controlling voltage and frequency. The authors of (Carvalho et al., 2008) demonstrated a control approach for reactive power with the aim of ensuring that voltage rise in an embedded distribution network do not result from active power generation. The strategy was proven to be effective for various loading conditions.

Beyond the voltage fluctuations, (Kavitha and Subramanian, 2017) showed that sensitive equipment could mal-operate as well as protective devices and communication systems. A couple of power enhancement devices were presented in his work to improve power quality which includes transient voltage surge suppressors, isolation transformers, unified power quality conditioner, static Var compensators, noise filters and harmonic filters. In as much as faults may not be eliminated from a power system, their occurrence should not result in total blackout or shut down of the system. Supervisory, Monitoring and Control technologies (SCADA) have been developed to handle problems with electrical networks in a way that normal operation of the power system can continue even after a fault occurs (Schweitzer et al., 2010). According (Souza et al., 2014), voltage security assessment is another area where research has been done and the Neuro-fuzzy adaptive network was employed for predictive operating of renewable sources in DN by investigating the load margin to attend to predicting renewable sources availability in the distribution power systems. Li et al. (2017) presented a directional pilot safety approach that is dependent on the flow of fault current in the positive sequence. The scheme compares the fault current through the positive sequence at both ends of a double-ended phase to recognise the phase with fault for isolation of the faulty circuit. The effectiveness of the method was tested by using MATLAB/SIMULINK.

The traditional system employs widespread transmission and distribution apparatus that typically uses 6-7% of the total transmitted power, representing major transmission and distribution losses (Sadovskaia et al., 2019; Sayed and Massoud, 2019). Due to the enormous challenges posed by the traditional systems, electricity suppliers and investors are seeing distributed generation as an instrument to create customized products for customers who have unique preferences for electricity service types. Distributed generation has therefore introduced elasticity options for electricity sector plays to respond to the varying economic environment, especially in liberalized markets which is practically made possible by the ease of their construction and small sizes (Navon et al., 2020).

Globally, one of the robust driving forces for distributed generation currently is environmental policies favouring renewable, cleaner and cost-saving technologies. Thus, organizations with huge need for both heat and electricity can optimize their energy consumption (Zhang et al., 2019).

With a population of over 200 million persons in Nigeria, a total generating capacity of 12, 522MW and daily available distribution of below 5,000 MW from the grid coupled with frequent outages and gross inefficiency, a lot of socio-economic activities are grounded owing to the bleak energy system. With only about 50% of the population are connected to the grid the distributed generation model comes in as a very appropriate alternative source for a country with an electricity demand of 90,000MW (Adewuyi, 2020; Adewuyi et al., 2020). There are lots of clean and renewable energy sources like Solar, wind, Hydro, and Biomass, which can come readily handy in implementing distributed generation technologies with the right energy policies in place (Dehghani-Sanij et al., 2019).

In this study, we examined the quality of the output power of a 30-bus Nigerian distribution system with high penetration of distribution generation system compared with the existing on-grid public utility system. The results of the simulation are compared, and inference made under various operating conditions while noting their adherence to permissible voltage limits. The benefit of the study to the generators and consumers of power and to the environment include reduction in Energy losses and improvement of power quality and stability. The study equally presents policy makers and energy investors a clear perspective on options for investment in the power generation and distribution.

This method guarantees a constant quality voltage at all nodes at full loading condition in a 30-bus distribution network. The method adopted for this research also demonstrated that the distributed generation system showed steady state stability by quickly recovering from small disturbances and maintaining quality voltage profile. We also used this method to investigate the relationship between the length of lines and voltage deviation in a grid-infeed network. The NEPLAN simulation enabled us to verify that the voltage values measured across buses fed with very long lines are significantly lower than those fed by shorter lines. The farther the source the higher the voltage deviation. The results from the NEPLAN simulation present acceptable quality voltages at all nodes and buses on the adopted network. Incidences of overvoltages or undervoltages are eliminated in the results.

The remaining sections in this study is arranged in the following order: The methodology, which involves conceptual frameworks as well as the mathematical formulations for the study are given in section 2 and the simulations and network descriptions are explained in section 3. The results of the model are presented in chapter 4 and the paper is concluded in section 5.

## 2. METHODS

Induction generators are also widely deployed in distributed generation due to the economic and compressed design benefits they present. This is why they are well deployed in renewable energy sources (Chiradeja, 2005). With respect to the characteristic of the output of the renewable sources, DGM seen as a model with constant power factor, constant voltage and or variable reactive power (Musa et al., 2013; Teng, 2008). The Load flow method for this study is founded on the BIBC and BCBV matrices, which are useful in studying the relationships that exist between current flowing and voltage at each bus as explained in (Teng, 2003). The mathematical representation of current injections and branch currents is given in equation (1)

$$[B]=[BIBC][I] \tag{1}$$

where  $[B]$  is the vector of branch current injection and  $[I]$  the vector of bus current injection.

The mathematical representation for branch currents and bus voltages is given in equation (2)

$$[V_0]-[V]=[BCBV][B] \tag{2}$$

where  $[V]$  represents the vector of the bus voltage and  $[V_0]$  is represents the vector of no-load bus voltages.

### 2.1. Calculation of Reactive Power Output of Distributed Generator Where Power Factor is Kept Constant (Synchronous Generators)

In this model, the given values are the real power output and power factor of the Distributed Generator while power factor is kept constant. To modify the output of a synchronous generator, we can inject different values of excitation current and for power electronics units, we input several values of trigger angles. The consequent Reactive power output, keeping power factor constant is computed as follows (Chen et al., 1991):

$$Q_i=P_i \tan(Cos^{-1}PF_i) \tag{3}$$

The equivalent current injected in the distributed generator is expressed as

$$I_i = I_i^1(V_i^k) + jI_i^1(V_i^k) = \left[ \frac{P_i + Q_i}{V_i^k} \right] \tag{4}$$

where

$P_i$  is the real output power of the Distributed Generator at bus  $i$   
 $V_i^k$  is the voltage output of the Distributed Generator ( $k$  is the iteration number).

$PF_i$  is the DG power factor at bus  $i$

$Q_i$  represents the DG reactive power at bus  $i$ .

This model is executed on a big variable Distributed Generation. The DG model is rated in terms of the active power output and voltage magnitude of the busbars. For a generator modelled as constant voltage at bus  $i$ , the reactive power for  $m$ th and  $k$ th iteration is obtained based on the two-loop algorithm analysis (Chen et al., 1991) as follows:

$$\Delta Q_i^{k,m} = V_i^{mis} (2[X_g])^{-1} \tag{5}$$

$$V_i^{mis} = \left( |V_i^{spec}| \right)^2 - \left( |V_i^{k,m}| \right)^2 \tag{6}$$

$$[X_g] = \text{img} \left( [BCBV_i] [BIBC_i] \right) \tag{7}$$

where  $\Delta Q_i^{k,m}$  is the changes in the reactive power,  $V_i^{mis}$  is the updated voltage,  $[X_g] = \text{img} \left( [BCBV_i] [BIBC_i] \right)$  is the column vector of  $[BIBC]$  corresponding to bus  $i$  and  $[X_g] = \text{img} \left( [BCBV_i] [BIBC_i] \right)$  is the horizontal vector of  $[BCBV]$  corresponding to bus  $i$ .

The Generated Output Power (GOP) can easily be expressed as

$$GOP = \text{combined active components} + \text{reactive power components} \tag{8}$$

$$GOP = P^{k,m} + j(Q^{k,m} + \Delta Q^{k,m}) \tag{9}$$

$$GOP = P^{k,m+1} + jQ^{k,m+1} \tag{10}$$

where  $\Delta Q^{k,m}$  = reactive power variation obtained from equation (5). We can therefore calculate the voltage ( $V_i^{k,m+1}$ ) of bus  $i$  for the  $(m + 1)^{th}$  inner iteration as follows.

$$V_i^{k,m+1} = V_i^{k,m} + \Delta V_i^{k,m} \tag{11}$$

### 2.2. Calculation of Reactive Power Output of Distributed Generator for a Variable Reactive Power (Induction Generators)

The calculation in this case is done in steady state for the sake of simplicity. It should be noted here that the real power output is a function of the wind speed (as in induction generators) while the reactive power is a function of both the real power and the impedance as detailed in (Feijoo and Cidras, 2000). We therefore obtain the reactive power function, as:

$$Q_i^1 = -Q_0 - Q_1 P_i - Q_2 P_i^2 \tag{12}$$

Where  $Q_i^1$  is the reactive power expended  $Q_0$ ,  $Q_1$  and  $Q_2$  parameters are derived from experiment.

Power factor correction strategy can be employed using capacitor banks for a case where the distribution system cannot fully supply the consumed reactive power. In this case, total reactive power ( $Q_i$ ) is the sum of the reactive power function expended by the wind turbine ( $Q_i^1$ ) and the reactive power supplied by the capacitor banks ( $Q_i^c$ ), expressed as

$$Q_i = Q_i^1 + Q_i^c \tag{13}$$

## 3. NETWORK DESCRIPTION

The one-line diagram of the network used for the purpose testing the effectiveness of the approach suggested in this paper is shown in Figure 1.

This network is the sub-network of the Nigerian medium and low voltage distribution with a total sub-network buses of 30-bus. This network consists of 11 number of outgoing 33-kV feeders at the Alagbon and Ajah 330/132/33-kV transmission station which terminate at many 33/11-kV injection substations as shown in Figure 1. In this study, the Ademola bus is regarded as the major load centre with respect to the several circuits connected at the bus. Consequently, this bus would need more than one DG sources to be carefully integrated by interconnectors. The network is simulated with data gathered from the Eko Electricity Distribution Plc (Bulatov et al., 2018) using the NEPLAN Software.

## 4. RESULTS AND DISCUSSION

In this section, simulation results are presented and discussed.

### 4.1. Grid In-feed Simulation

The load flow results presented in Table 1 were obtained after loading the buses under grid In-feed scenario. The results presented in Table 1 are obtained from the 30-bus model of the Nigerian system used as the case study. The negative polarity in the values of the phase angles indicates that the associated buses have more of inductive loads which implies that the power factor is lagging (current lags voltage).

### 4.2. Full Load Voltage Profile for Grid In-feed

The per unit voltages of the various buses are collated and compared with their respective voltage deviations as shown in Table 2. It is observed that only two nodes (Alagbon and Ajah Buses) have the best quality owing to their minimal voltage deviations (-2% each) while most node voltages fall outside the permissible limits as seen from Figure 2.

Maroko 2 and Ademola 2 buses have the largest deviation magnitude with both greater than -11%. These voltage values are

Figure 1: The 30-bus Nigerian Distribution Network modelled in the NEPLAN environment

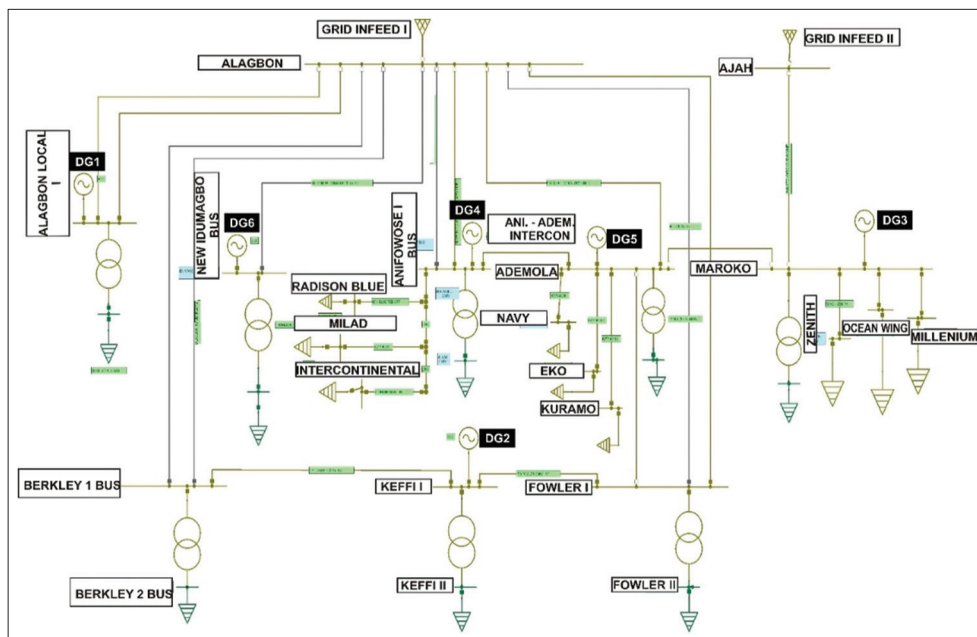

practically unusable which implies huge losses and inefficiency in the distribution network. From Figure 2, we observe a constant trend of full load per unit voltages on Ajah, Alagbon and Alagbon Local 1 buses; this is owing to their proximity to the Grid in-feed station as seen from Figure 1. In Figure 3, the node with the farthest deviation is measured to be Maroko 2 bus with deviation of -13.01%. Our investigations show that the Maroko 2 bus happens to be the bus that is fed with the longest line in the network (Ajah/Maroko line - 23Km). The results presented in Table 2 and Figure 3 investigated the relationship between

the length of a line and the voltage deviation on a Grid In-feed Network. The results show that the longest lines have significantly huge voltage deviations at their terminal ends measured from the power source. Voltage deviations of -13.01%, -11.92% and -11.31% were measured at Maroko 2, Ademola 2 and Anifowose 2 buses respectively. These buses are fed with the longest lines in the distribution network with the shortest of them measured to be 19.2km. The nodes with the least voltage deviation is measured to be Ajah, Alagbon and Alagbon Local 1 buses with percentage voltage of 98% each.

**Table 1: Load flow results from grid in-feed simulation**

S/N	Name	V	V angle	P Load	Q Load	P Gen	Q Gen
		%	Ø	MW	MVar	MW	MVar
1	ADEMOLA 1 BUS	92.54	-0.2	0.000	0.000	0.000	0.000
2	ADEMOLA 2 BUS	88.08	-4.0	25.200	15.618	0.000	0.000
3	AJAH BUS	98.00	0.0	0.000	0.000	21.024	14.564
4	ALAGBON BUS	98.00	0.0	0.000	0.000	164.926	112.876
5	ALAGBON LOCAL 1 BUS	97.90	0.0	0.000	0.000	0.000	0.000
6	ALAGBON LOCAL 2 BUS	92.57	-4.7	22.90	12.77	0.000	0.000
7	ANIFOWOSHE 1 BUS	93.48	-0.1	0.000	0.000	0.000	0.000
8	ANIFOWOSHE 2 BUS	88.69	-4.1	27.200	16.857	0.000	0.000
9	BERKLEY 1 BUS	95.41	-0.4	0.000	0.000	0.000	0.000
10	BERKLEY 2 BUS	93.00	-2.5	14.700	9.110	0.000	0.000
11	EKO HOTEL BUS	92.43	-0.2	9.000	5.578	0.000	0.000
12	FOWLER 1 BUS	94.88	-0.1	0.000	0.000	0.000	0.000
13	FOWLER 2 BUS	92.32	-2.3	15.500	9.606	0.000	0.000
14	INTERCONTINENTAL HOTEL 1 BUS	93.32	-0.1	0.000	0.000	0.000	0.000
15	INTERCONTINENTAL HOTEL 2 BUS	93.29	-0.1	1.200	0.744	0.000	0.000
16	KEFFI 1 BUS	94.14	-0.1	0.000	0.000	0.000	0.000
17	KEFFI 2 BUS	89.31	-4.2	9.200	5.702	0.000	0.000
18	KURAMO TOWER BUS	92.48	-0.2	2.000	1.239	0.000	0.000
19	MAROKO 1 BUS	91.01	-0.2	0.000	0.000	0.000	0.000
20	MAROKO 2 BUS	86.99	-3.7	15.000	9.296	0.000	0.000
21	MILAD 1 BUS	93.33	-0.1	1.000	0.620	0.000	0.000
22	MILAD 2 BUSs	93.36	-0.1	0.000	0.000	0.000	0.000
23	MILLENIUM BUS	90.92	-0.2	2.000	1.239	0.000	0.000
24	NAVY DOCKYARD BUS	92.45	-0.2	2.200	1.363	0.000	0.000
25	NEW IDUMAGBO BUS	94.64	-0.1	0.000	0.000	0.000	0.000
26	NEW IDUMAGBO BUS	91.66	-2.7	11.900	7.375	0.000	0.000
27	OCEAN WING BUS	90.98	-0.2	1.300	0.806	0.000	0.000
28	RADISON BLUE	93.39	-0.1	0.000	0.000	0.000	0.000
29	RADISON BLUE BUS	93.37	-0.1	1.000	0.620	0.000	0.000
30	ZENITH BUS	90.95	-0.2	1.200	0.744	0.000	0.000

**Figure 2: Full-load voltage profile (per unit voltage) for grid in-feed**

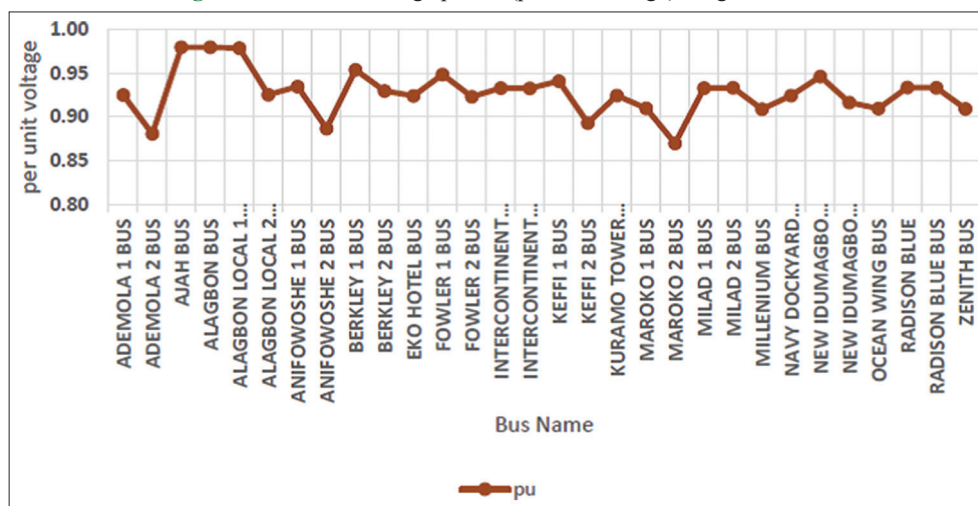

**Table 2: Full load voltage profile (grid in-feed)**

S/N	Name	Percentage Voltage %	Per Unit Voltage	Voltage deviation %
1	ADEMOLA 1 BUS	92.54	0.93	-7.46
2	ADEMOLA 2 BUS	88.08	0.88	-11.92
3	AJAH BUS	98.00	0.98	-2
4	ALAGBON BUS	98.00	0.98	-2
5	ALAGBON LOCAL 1 BUS	97.90	0.98	-2.1
6	ALAGBON LOCAL 2 BUS	92.57	0.93	-7.43
7	ANIFOWOSHE 1 BUS	93.48	0.93	-6.52
8	ANIFOWOSHE 2 BUS	88.69	0.89	-11.31
9	BERKLEY 1 BUS	95.41	0.95	-4.59
10	BERKLEY 2 BUS	93.00	0.93	-7.00
11	EKO HOTEL BUS	92.43	0.92	-7.57
12	FOWLER 1 BUS	94.88	0.95	-5.12
13	FOWLER 2 BUS	92.32	0.92	-7.68
14	INTERCONTINENTAL HOTEL 1 BUS	93.32	0.93	-6.68
15	INTERCONTINENTAL HOTEL 2 BUS	93.29	0.93	-6.71
16	KEFFI 1 BUS	94.14	0.94	-5.86
17	KEFFI 2 BUS	89.31	0.89	-10.69
18	KURAMO TOWER BUS	92.48	0.92	-7.52
19	MAROKO 1 BUS	91.01	0.91	-8.99
20	MAROKO 2 BUS	86.99	0.87	-13.01
21	MILAD 1 BUS	93.33	0.93	-6.67
22	MILAD 2 BUS	93.36	0.93	-6.64
23	MILLENIUM BUS	90.92	0.91	-9.08
24	NAVY DOCKYARD BUS	92.45	0.92	-7.55
25	NEW IDUMAGBO BUS	94.64	0.95	-5.36
26	NEW IDUMAGBO BUS	91.66	0.92	-8.34
27	OCEAN WING BUS	90.98	0.91	-9.02
28	RADISON BLUE	93.39	0.93	-6.61
29	RADISON BLUE BUS	93.37	0.93	-6.63
30	ZENITH BUS	90.95	0.91	-9.05

**Figure 3:** Network voltage deviation characteristics for the grid in-feed

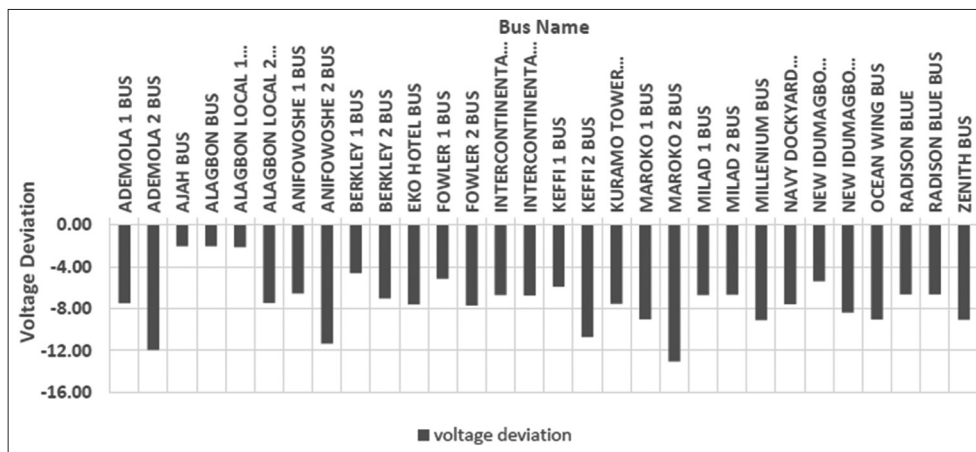

The length of the lines feeding them each are less or equal to 0.3 km. Under voltages are recorded in 23 buses representing 77% of the total buses under consideration. This percentage of under-voltage describes the enormous shortcoming of the power quality that this grid-infeed distribution network possesses.

**4.3. Distributed Generation In-feed Simulation**

In this case, the Network is fed with power from six Generators (DG 1, DG 2, DG 3, DG 4, DG 5 and DG 6), integrated into the network at different buses. The locations of the generators were chosen based on loading information obtained from the utility company. The results presented in Table 3 were obtained after loading the buses under distributed generation condition.

**4.4. Full Load Voltage Profile for Distributed Generation In-feed**

The per unit voltages of the various buses are collated and compared with their respective voltage deviations as shown in Table 4. It is observed that all the 30-buses under consideration have quality voltages with the least deviation of -5.19% at Alagbon Local 1 Bus. The results from Table 3 clearly showed that all node voltages fall within the permissible voltage limits for the Distributed generation in-feed.

From Table 4, six buses (representing 20%) have zero voltage deviations implying that voltage values are at their peak quality. These buses are namely Ademola 2, Alagbon Local 2, Anifowose

2, Keffi 2, Maroko 2 and New Idumagbo 2 buses. From Figure 4, we observe a nearly constant voltage trend showing about 20 buses (representing 67% of all buses) which have almost 1.0 per unit voltage or infinitesimal voltage deviations as shown by the results of Table 4. This percentage of constant voltage is a representation of the efficacy of Distributed Generation fed distribution networks.

In Figure 5, 80% of all bus voltages have less than -2% voltage deviation which represents a quality voltage profile, although all the 30 buses are within acceptable voltage limits.

### 4.5. Permissible Voltage Drops

It is normal for Voltage drops to occur in a distribution network, and as such, voltages are regulated to keep the voltage drops within a permissible range (Li et al., 2019). Operating devices outside the permissible range adversely affect its functionality and increase in maintenance costs (Ren et al., 2019). Going by the relationship between power and voltage, reducing the voltage by beyond 10% will reduce the power output by about 19% (Li et al., 2019; Ullah et al., 2013). Information from Li et al. (2019); Ren et al. (2019); Ullah et al. (2013) and the Transmission Company of Nigeria

**Table 3: Load flow results from distributed generation in-feed simulation**

S/N	Name	Voltage magnitude	Voltage angle	P Load	Q Load	P Gen	Q Gen
		%	Ø	MW	MVar	MW	MVar
1	ADEMOLA 1 BUS	95.94	-3.2	25.20	15.62	0.000	0.000
2	ADEMOLA 2 BUS	100.0	0.0	0.000	0.000	38.52	25.93
3	AJAH BUS	0.000	0.0	0.000	0.000	0.000	0.000
4	ALAGBON BUS	0.000	0.0	0.000	0.000	0.000	0.000
5	ALAGBON LOCAL 1 BUS	94.81	-4.5	22.90	12.77	0.000	0.000
6	ALAGBON LOCAL 2 BUS	100.0	0.0	0.000	0.000	23.03	15.32
7	ANIFOWOSHE 1 BUS	95.58	-3.5	27.20	16.86	0.000	0.000
8	ANIFOWOSHE 2 BUS	100.0	0.0	0.000	0.000	31.33	21.83
9	BERKLEY 1 BUS	97.29	-1.9	14.70	9.11	0.000	0.000
10	BERKLEY 2 BUS	99.58	0.0	0.000	0.000	0.000	0.000
11	EKO HOTEL BUS	99.90	0.0	9.000	5.578	0.000	0.000
12	FOWLER 1 BUS	95.95	-2.1	15.50	9.606	0.000	0.000
13	FOWLER 2 BUS	98.42	-0.1	0.000	0.000	0.000	0.000
14	INTERCONTINENTAL HOTEL 1 BUS	99.85	0.0	0.000	0.000	0.000	0.000
15	INTERCONTINENTAL HOTEL 2 BUS	99.82	0.0	1.200	0.744	0.000	0.000
16	KEFFI 1 BUS	95.51	-3.6	9.200	5.702	0.000	0.000
17	KEFFI 2 BUS	100.0	0.0	0.000	0.000	50.63	33.73
18	KURAMO TOWER BUS	99.95	0.0	2.000	1.239	0.000	0.000
19	MAROKO 1 BUS	96.40	-2.9	15.00	9.296	0.000	0.000
20	MAROKO 2 BUS	100.0	0.0	0.000	0.000	19.56	13.20
21	MILAD 1 BUS	99.86	0.0	1.000	0.620	0.000	0.000
22	MILAD 2 BUS	99.88	0.0	0.000	0.000	0.000	0.000
23	MILLENIUM BUS	99.92	0.0	2.000	1.239	0.000	0.000
24	NAVY DOCKYARD BUS	99.92	0.0	2.200	1.363	0.000	0.000
25	NEW IDUMAGBO BUS	97.19	-2.3	11.90	7.375	0.000	0.000
26	NEW IDUMAGBO BUS	100.0	0.0	0.000	0.000	16.15	10.68
27	OCEAN WING BUS	99.97	0.0	1.300	0.806	0.000	0.000
28	RADISON BLUE	99.91	0.0	0.000	0.000	0.000	0.000
29	RADISON BLUE BUS	99.89	0.0	1.000	0.620	0.000	0.000
30	ZENITH BUS	99.95	0.0	1.200	0.744	0.000	0.000

**Figure 4: Full load voltage profile (per unit voltage) for distributed generation in-feed**

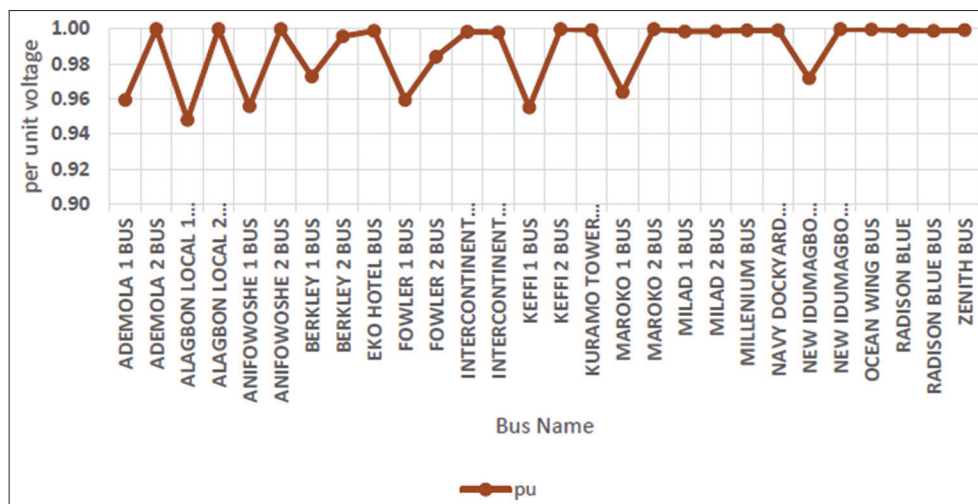
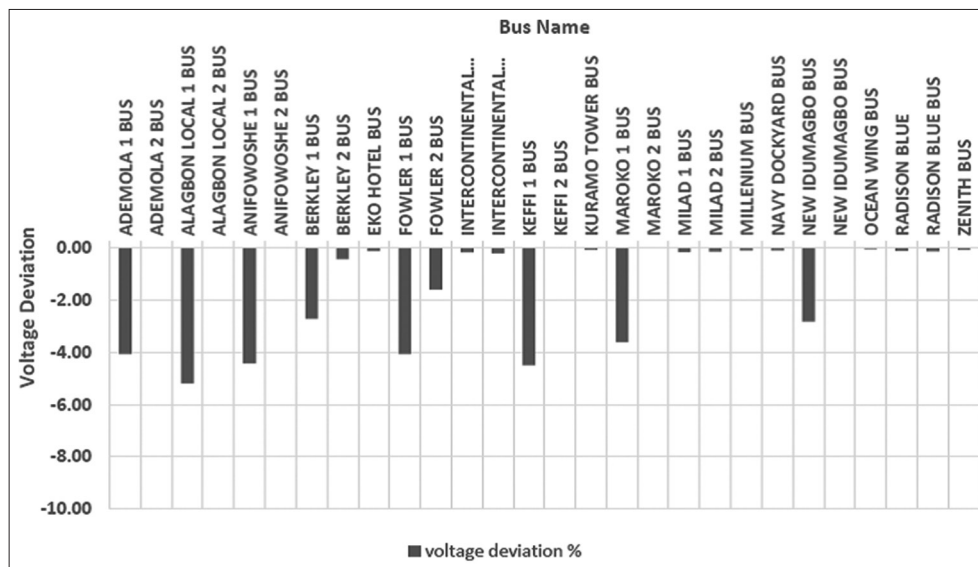



**Table 4: Full load voltage profile (distributed generation in-feed)**

S/N	Name	Per Unit Voltage	Voltage deviation (%)
1	ADEMOLA 1 BUS	0.96	-4.06
2	ADEMOLA 2 BUS	1.00	0.00
3	AJAH BUS	0.00	N/A
4	ALAGBON BUS	0.00	N/A
5	ALAGBON LOCAL 1 BUS	0.95	-5.19
6	ALAGBON LOCAL 2 BUS	1.00	0.00
7	ANIFOWOSHE 1 BUS	0.96	-4.42
8	ANIFOWOSHE 2 BUS	1.00	0.00
9	BERKLEY 1 BUS	0.97	-2.71
10	BERKLEY 2 BUS	1.00	-0.42
11	EKO HOTEL BUS	1.00	-0.10
12	FOWLER 1 BUS	0.96	-4.05
13	FOWLER 2 BUS	0.98	-1.58
14	INTERCONTINENTAL HOTEL 1 BUS	1.00	-0.15
15	INTERCONTINENTAL HOTEL 2 BUS	1.00	-0.18
16	KEFFI 1 BUS	0.96	-4.49
17	KEFFI 2 BUS	1.00	0.00
18	KURAMO TOWER BUS	1.00	-0.05
19	MAROKO 1 BUS	0.96	-3.60
20	MAROKO 2 BUS	1.00	0.00
21	MILAD 1 BUS	1.00	-0.14
22	MILAD 2 BUS	1.00	-0.12
23	MILLENIUM BUS	1.00	-0.08
24	NAVY DOCKYARD BUS	1.00	-0.08
25	NEW IDUMAGBO 1 BUS	0.97	-2.81
26	NEW IDUMAGBO 2 BUS	1.00	0.00
27	OCEAN WING BUS	1.00	-0.03
28	RADISON BLUE	1.00	-0.09
29	RADISON BLUE BUS	1.00	-0.11
30	ZENITH BUS	1.00	-0.05

**Figure 5: Voltage deviation characteristics for distributed generation in-feed**



specifies the following voltage limits on distribution circuits as shown in Table 5:

#### 4.6. Comparison of Results

The results from both case studies are compared to establish the differences, relationships, deviations from nominal or ideal situations. The following Table 6 shows the Load flow results at different buses with both Grid In-feed and Distributed Generation In-feed, respectively.

It can be observed from the Table 6 that for Grid In-feed network, a total of 23 nodes recorded an under voltage (less than -6% voltage permissible deviations). This means that over two-thirds of the entire bus voltages are non-desirable in the network. The implication of the presence of these undesirable and low voltages in the network implies demand for more current (for constant loads), as seen from the Power (P), Voltage (V) and Current(I) relationship ( $P=VI$ ). This high current results in wire losses and short circuits. To this end, we employ the Distributed Generation

as a solution to the power quality problem of poor bus voltages. Since buses are points of multiple connections, poor voltage at the buses translates to increased losses to both the utility company and the end users. In contrast, the voltages obtained in the Distributed generation all fall within the permissible limits. This is a case of 33% against the 100% for Grid In-feed and Distributed Generation, respectively.

From Table 6, we observe that Ajah and Alagbon Buses are disconnected in the Distributed Generation In-feed and as such, there are no values for Voltage deviation.

As seen in Figure 6, the Voltage deviations for Grid In-feed for 29 buses all lag the deviations for Distributed Generation In-feed except for Alagbon Local 1 Bus. This shows that the Embedded Generation Voltage profile has better quality in about 97% of all nodes when compared with the Grid In-feed. Maroko Bus was observed to have the highest deviation. This is traceable to the

line losses resulting from the length of Ajah-Maroko line, which is the longest on the network (23 km).

The implication of under-voltage in electrical power systems is the high maintenance costs resulting from damage to windings of transformers and to the end users, their inductive loads will overheat and consume more power (implying increased electricity tariff) and their resistive loads will not operate at optimum capacity. In general, it can be deduced that the voltage profile for a circuit using Distributed Generation is steadier and of a better quality compared with a circuit having Grid In-feed.

**4.7. Real and Reactive Power Losses**

The level of power loss owing to line losses and bus elements is a good indication of the quality of power in such network. We shall examine the power losses for grid in-feed and distributed generation in-feed, respectively.

It can be observed from Table 7 that for the grid in-feed, a significant amount of Real and Reactive Power of 7.109 MW and 5.590 MVAR respectively accruing to the transmission lines are lost in the load flow results. The main reason for Distributed Generation (DG) incorporation into distribution networks is to reduce to the barest minimum, the losses, which are undesirable in power systems. This is necessary as these losses do result in severe wear and tear of power equipment, thereby increasing the maintenance costs of the network equipment. By applying Distributed Generation to the same network, we succeeded in

**Table 5: Permissible voltage limits on distribution circuits**

Level of reference	Nominal voltage rating (kV)	Tolerance allowed (kV)	
		Lower limit	Upper limit
		-6%	+6%
Primary distribution level	33	31.02	34.98
Secondary distribution level	11	10.34	11.66

**Table 6: Comparison of results for the grid in-feed and distributed generation in-feed**

S/N	Bus name	Grid in-feed		Dg in-feed	
		p.u voltage	Voltage deviation (%)	p.u voltage	Voltage deviation (%)
1	ADEMOLA 1 BUS	0.93	-7.46	0.96	-4.06
2	ADEMOLA 2 BUS	0.88	-11.92	1.00	0.00
3	AJAH BUS	0.98	-2.00	0.00	N/A
4	ALAGBON BUS	0.98	-2.00	0.00	N/A
5	ALAGBON LOCAL 1 BUS	0.98	-2.10	0.95	-5.19
6	ALAGBON LOCAL 2 BUS	0.93	-7.43	1.00	0.00
7	ANIFOWOSHE 1 BUS	0.93	-6.52	0.96	-4.42
8	ANIFOWOSHE 2 BUS	0.89	-11.31	1.00	0.00
9	BERKLEY 1 BUS	0.95	-4.59	0.97	-2.71
10	BERKLEY 2 BUS	0.93	-7.00	1.00	-0.42
11	EKO HOTEL BUS	0.92	-7.57	1.00	-0.10
12	FOWLER 1 BUS	0.95	-5.12	0.96	-4.05
13	FOWLER 2 BUS	0.92	-7.68	0.98	-1.58
14	INTERCONTINENTAL HOTEL 1 BUS	0.93	-6.68	1.00	-0.15
15	INTERCONTINENTAL HOTEL 2 BUS	0.93	-6.71	1.00	-0.18
16	KEFFI 1 BUS	0.94	-5.86	0.96	-4.49
17	KEFFI 2 BUS	0.89	-10.69	1.00	0.00
18	KURAMO TOWER BUS	0.92	-7.52	1.00	-0.05
19	MAROKO 1 BUS	0.91	-8.99	0.96	-3.60
20	MAROKO 2 BUS	0.87	-13.01	1.00	0.00
21	MILAD 1 BUS	0.93	-6.67	1.00	-0.14
22	MILAD 2 BUS	0.93	-6.64	1.00	-0.12
23	MILLENIUM BUS	0.91	-9.08	1.00	-0.08
24	NAVY DOCKYARD BUS	0.92	-7.55	1.00	-0.08
25	NEW IDUMAGBO 1 BUS	0.95	-5.36	0.97	-2.81
26	NEW IDUMAGBO 2 BUS	0.92	-8.34	1.00	0.00
27	OCEAN WING BUS	0.91	-9.02	1.00	-0.03
28	RADISON BLUE	0.93	-6.61	1.00	-0.09
29	RADISON BLUE BUS	0.93	-6.63	1.00	-0.11
30	ZENITH BUS	0.91	-9.05	1.00	-0.05

**Table 7: Comparison of power losses for the grid in-feed and distributed generation in-feed**

Network type	Line Real Power (P) Loss MW	Line Reactive Power (Q) Loss MVar	Transformer Real Power(P) Loss MW	Transformer Reactive Power(Q) Loss MVar
Grid in-feed	7.109	5.590	0.641	12.833
Dg in-feed	0.446	0.340	0.566	11.318

**Figure 6: Comparison of voltage deviations for grid and distributed generation in-feed**

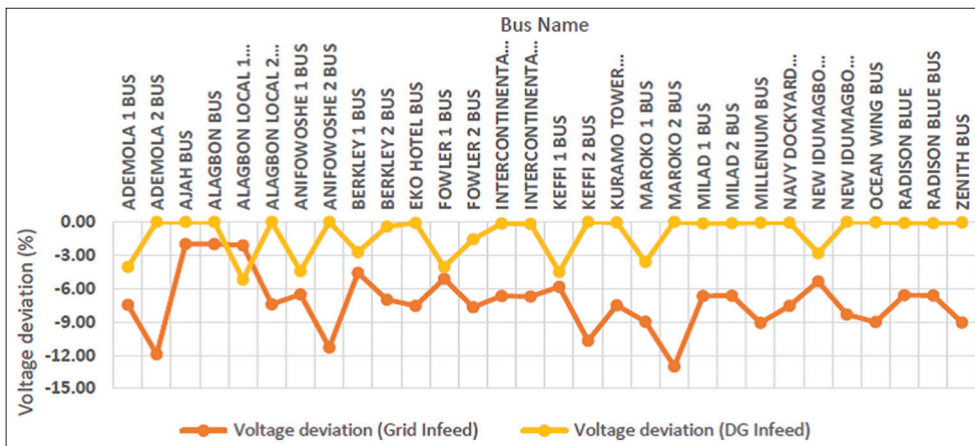

**Figure 7: Comparison of total real power loss for line and transformer in grid and distributed generation**

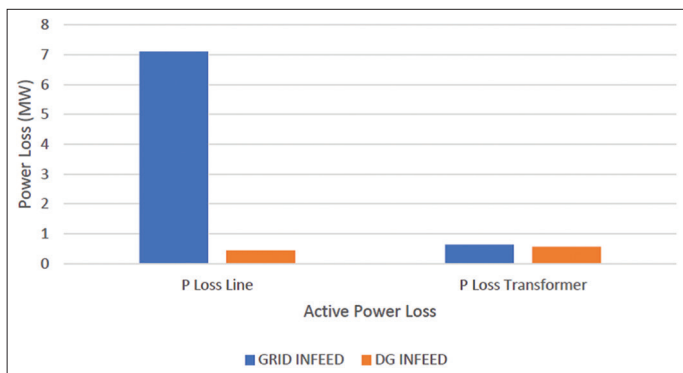

**Figure 8: Comparison of total reactive power loss for line and transformer in grid and distributed generation**

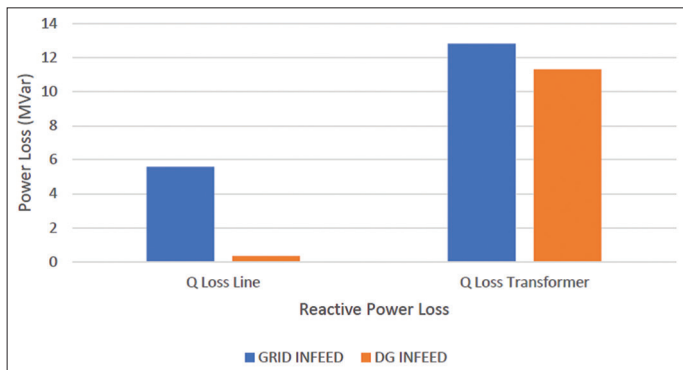

achieving a saving of 6.663MW (94% reduction) and 5.250MVar (94% reduction) of real and Reactive Power, respectively. Some of the technical losses as seen from the results are traceable to the lengthy nature of lines on the Grid in-feed network where 70% of the lines are longer than 10Km each. This characteristic

disposition of Grid in-feed networks results in high line resistance, which implies high losses in the line. Since Nigerian distribution lines are radial, the KVA x KM capacity selection criteria for standard conductors ought to be employed for required voltage regulation but from the NEPLAN simulation data utilized in this study, this criterion is not strictly adhered to in the Nigerian Distribution network. The losses in the Grid In-feed network are also attributable to this factor due to their lengthy nature. Figures 7 and 8 adequately show this wide margin between the line losses for both case studies. The transformer losses are also depicted in Table 6 which shows a 12% reduction in both real power and reactive power loss from 0.641MW to 0.566MW and 12.833MVar to 11.0318Mvar for Grid and Distributed Generation, respectively. This is visible in Figures 7 and 8 respectively. Overloading of traditional Grid In-feed networks is also a major factor contributing to the losses recorded. This is the reason that six distribution generators are strategically cited in the vicinity of heavily loaded buses (Alagbon Local, Anifowose, Ademola, New Idumagbo, Keffi-Fowler, and Maroko) as seen in Figure 1.

In order to reduce the reactive power losses associated with lines, we identified an overloaded line on Keffi-Fowler Line and incorporated the Unified Power Flow Controller (UPFC) on the line (Nick et al., 2017; Tong et al., 2019). This successfully led to a decrease of the network loading from 112% to 88%. In general, it can be deduced that the Real and Reactive Power loss incurred when employing Distributed Generation is far less compared with a circuit having Grid In-feed.

### 5. CONCLUSION

In this paper, the competitive advantage that Distributed Generation has over traditional grid has been demonstrated using the NEPLAN simulation software with real data from the

existing Power utility company. The results clearly showed that all node voltages fall within the permissible voltage limits for the Distributed generation in-feed while most node voltages fall outside the permissible limits for grid in-feed. 30 out of 30 buses representing 100% of all the buses under consideration have quality voltages for utilization. This is a contrast as against 9 out of 30 buses representing 30% of the total buses under consideration for Grid Infeed. The buses with the highest deviations are Alagbon bus (-5%) for the Distributed Generation Infeed, and Maroko bus (-13%) for the Grid Infeed. There is a nearly constant voltage profile recorded on the distributed generation network even at full loading conditions. Improved voltage profile implies that the end users are able to get value for their monies and for the distribution company, the maintenance costs are reduced on their equipment which translates to extra savings as well as elongated operational lifespan for the equipment. We also experimented with network worst scenario of load fluctuations by switching out certain buses and lines at full loading condition and the system recovered quickly by maintaining quality voltage, implying a robust system. This test is also a major indication of Transient State Stability.

The study demonstrated that real power and reactive power losses accruing to lines in a traditional grid network are significantly reduced by 93.7% (from 7.109MW to 0.446MW); and 93.9% (from 5.59MVar to 0.34MVar) with the introduction of Distributed Generation using the same operating parameters. Similarly, the real power and reactive power losses accruing to transformers in a traditional grid network are significantly reduced by 11.7% (from 0.641MW to 0.556MW); and 11.8% (from 12.833MVar to 11.318MVar) with the introduction of Distributed Generation. Furthermore, our results showed that the longest lines have significantly huge voltage deviations at their terminal ends measured farthest from the power source. Voltage deviations of -13.01%, -11.92% and 11.31% were measured at Maroko 2, Ademola 2 and Anifowose 2 buses respectively. This research presents power investors, options for investment and policy direction to Governments across the world where power generation and traditional grid transmission of same is a burdensome challenge.

## 6. ACKNOWLEDGMENT

The authors wish to acknowledge the management of Covenant University for her part sponsorship and support toward the success of this research work.

## REFERENCES

- Abdulkareem, A., Divine, O., Tobiloba, S. (2020), Review of different methods for optimal placement of phasor measurement unit on the power system network. *Advances in Science, Technology and Engineering Systems Journal*, 5(6), 1071-1081
- Adewuyi, A. (2020), Challenges and prospects of renewable energy in Nigeria: A case of bioethanol and biodiesel production. *Energy Reports*, 6, 77-88.
- Adewuyi, O.B., Kiptoo, M.K., Afolayan, A.F., Amara, T., Alawode, O.I., Senjyu, T. (2020), Challenges and prospects of Nigeria's sustainable energy transition with lessons from other countries' experiences. *Energy Reports*, 6, 993-1009.
- Ahmad, A.A.L., Sirjani, R. (2019), Optimal placement and sizing of multi-type FACTS devices in power systems using metaheuristic optimisation techniques: An updated review. *Ain Shams Engineering Journal*, 11(3), 611-628.
- Baghaee, H.R., Mirsalim, M., Gharehpetian, G.B., Talebi, H.A. (2016), Reliability/cost-based multi-objective Pareto optimal design of stand-alone wind/PV/FC generation microgrid system. *Energy*, 115, 1022-1041.
- Bulatov, Y.N., Kryukov, A.V., Suslov, K.V. (2018), Solving the Flicker Noise Origin Problem by Optimally Controlled Units of Distributed Generation. Naples, Italy: Paper Presented at the 2018 18<sup>th</sup> International Conference on Harmonics and Quality of Power (ICHQP).
- Carvalho, P.M.S., Correia, P.F., Ferreira, L.A.F. (2008), Distributed reactive power generation control for voltage rise mitigation in distribution networks. *IEEE Transactions on Power Systems*, 23(2), 766-772.
- Chen, T.H., Chen, M.S., Inoue, T., Kotas, P., Chebli, E.A. (1991), Three-phase cogenerator and transformer models for distribution system analysis. *IEEE Transactions on Power Delivery*, 6(4), 1671-1681.
- Chiradeja, P. (2005), Benefit of distributed generation: A line loss reduction analysis. Paper presented at the 2005 IEEE/PES Transmission and Distribution Conference and Exposition: Asia and Pacific. United States: Institute of Electrical and Electronics Engineers.
- Dehghani-Sani, A.R., Tharumalingam, E., Dusseault, M.B., Fraser, R. (2019), Study of energy storage systems and environmental challenges of batteries. *Renewable and Sustainable Energy Reviews*, 104, 192-208.
- Dulău, L.I., Abrudean, M., Bică, D. (2014), Effects of distributed generation on electric power systems. *Procedia Technology*, 12, 681-686.
- Feijoo, A.E., Cidras, J. (2000), Modeling of wind farms in the load flow analysis. *IEEE Transactions on Power Systems*, 15(1), 110-115.
- Ghiasi, M. (2019), Technical and economic evaluation of power quality performance using FACTS devices considering renewable generations. *Renewable Energy Focus*, 29, 49-62.
- Huy, P.D., Ramachandaramurthy, V.K., Yong, J.Y., Tan, K.M., Ekanayake, J.B. (2020), Optimal placement, sizing and power factor of distributed generation: A comprehensive study spanning from the planning stage to the operation stage. *Energy*, 195, 117011.
- Jacxsens, M., Meersman, B., Vandoor, T.L., De Kooning, J.D.M., Vandeveld, L. (2011), Overview of Voltage Control Strategies in Medium Voltage Networks with Implementation of Distributed Generation. Edinburgh: IET Conference on Renewable Power Generation.
- Jamil, M., Anees, A.S. (2016), Optimal sizing and location of SPV (solar photovoltaic) based MLDG (multiple location distributed generator) in distribution system for loss reduction, voltage profile improvement with economical benefits. *Energy*, 103, 231-239.
- Jenkins, N., Strbac, G. (1997), Impact of Embedded Generation on Distribution System Voltage Stability. London, UK: IEE Colloquium on Voltage Collapse.
- Kavitha, V., Subramanian, K. (2017), Investigation of Power Quality Issues and Its Solution for Distributed Power System. New Zealand: Paper Presented at the 2017 International Conference on Circuit, Power and Computing Technologies (ICCPCT).
- Li, C., Zhou, H., Li, J., Dong, Z. (2020), Economic dispatching strategy of distributed energy storage for deferring substation expansion in the distribution network with distributed generation and electric vehicle. *Journal of Cleaner Production*, 253, 119862.
- Li, J., Li, X., Cheng, W., Huang, C., Wang, W. (2019), Economic Analysis of Generation and Distribution Integrated System with

- High Penetration Distributed Generation. United Kingdom: Paper Presented at the IOP Conference Series: Materials Science and Engineering.
- Li, W., He, J., Zhang, D., Zhang, Q. (2017), Directional pilot protection based on fault current for distribution network with Distributed Generation (DG). *The Journal of Engineering*, 2017(13), 1327-1331.
- Marszal-Pomianowska, A., Widén, J., Le Dréau, J., Heiselberg, P., Bak-Jensen, B., de Cerio Mendaza, I.D. (2020), Operation of power distribution networks with new and flexible loads: A case of existing residential low voltage network. *Energy*, 202, 117715.
- Musa, I., Zahawi, B., Gadoue, S.M. (2013), Integration of Induction Generator Based Distributed Generation and Shunt Compensation Capacitors in Power Distribution Networks. Istanbul, Turkey: Paper Presented at the 4<sup>th</sup> International Conference on Power Engineering, Energy and Electrical Drives.
- Navon, A., Kulbekov, P., Dolev, S., Yehuda, G., Levron, Y. (2020), Integration of distributed renewable energy sources in Israel: Transmission congestion challenges and policy recommendations. *Energy Policy*, 140, 111412.
- Nick, M., Cherkaoui, R., Paolone, M. (2017), Optimal planning of distributed energy storage systems in active distribution networks embedding grid reconfiguration. *IEEE Transactions on Power Systems*, 33(2), 1577-1590.
- Ren, H., Wu, Q., Zhu, Q., Gao, W. (2019), Cost-benefit analysis of distributed energy systems considering multi-benefits and multi-stakeholders. *Energy*, 189, 116382.
- Sadovskaia, K., Bogdanov, D., Honkapuro, S., Breyer, C. (2019), Power transmission and distribution losses-a model based on available empirical data and future trends for all countries globally. *International Journal of Electrical Power and Energy Systems*, 107, 98-109.
- Sayed, S., Massoud, A. (2019), Minimum transmission power loss in multi-terminal HVDC systems: A general methodology for radial and mesh networks. *Alexandria Engineering Journal*, 58(1), 115-125.
- Schweitzer, E.O., Whitehead, D., Zweigle, G., Ravikumar, K.G. (2010), Synchrophasor-based Power System Protection and Control Applications. Texas: Paper Presented at the 2010 63<sup>rd</sup> Annual Conference for Protective Relay Engineers.
- Shomefun, T., Ademola, A., Awosope, C.O.A., Adekitan, A.I. (2018), Critical review of different methods for siting and sizing distributed-generators. *Telkomnika*, 16(5), 2395-2405.
- Sivaraman, P., Sharmeela, C., Kothari, D.P. (2017), Enhancing the Voltage Profile in Distribution System with 40 GW of Solar PV Rooftop in Indian Grid by 2022: A Review. New Delhi, India: Paper Presented at the 1<sup>st</sup> International Conference on Large Scale Grid Integration Renewable Energy in India.
- Somefun, T.E., Awosope, C.O.A., Abdulkareem, A., Alayande, A.S. (2020), Deployment of power network structural topology to optimally position distributed generator within distribution system. *Journal of Engineering Science and Technology Review*, 13(1), 12-17.
- Somefun, T.E., Babayomi, O., Awosope, C.O.A., Abdulkareem, A., Somefun, C.T. (2020), Software for Improved Online Teaching of Power System Analysis For Undergraduates. Paper Presented at the 2020 IEEE PES/IAS PowerAfrica.
- Souza, M.F.Z., Reis, Y., Almeida, A.B., Lima, I., Zambroni De Souza, A.C. (2014), A Neuro-fuzzy Method as Tool for Voltage Security Assessment of Systems with Distributed Generation. Naples: 3<sup>rd</sup> Renewable Power Generation Conference
- Teng, J.H. (2003), A direct approach for distribution system load flow solutions. *IEEE Transactions on Power Delivery*, 18(3), 882-887.
- Teng, J.H. (2008), Modelling distributed generations in three-phase distribution load flow. *IET Generation, Transmission and Distribution*, 2(3), 330-340.
- Tong, X., Zhong, M., Zhang, X., Deng, J., Zhang, Z. (2019), Voltage regulation strategy of AC distribution network based on distributed PV grid-connected inverter. *The Journal of Engineering*, 16, 2525-2528.
- Ullah, S., Arbab, M.N., Fattah, A. (2013), Integration of Distributed Generation into a Radial Distribution Feeder for Reduction of Line Losses. Turkey: Paper Presented at the 2013 The International Conference on Technological Advances in Electrical, Electronics and Computer Engineering (TAECE).
- Wang, Z., Perera, A.T.D. (2019), Robust optimization of power grid with distributed generation and improved reliability. *Energy Procedia*, 159, 400-405.
- Zhang, L., Qin, Q., Wei, Y.M. (2019), China's distributed energy policies: Evolution, instruments and recommendation. *Energy Policy*, 125, 55-64.
- Zhao, H., Liu, G., Jia, H., Yang, Z., Fan, S. (2013), Optimal Dispatching of Distributed Generation Based on Demand Response Programs. Mumbai: Paper Presented at the 2<sup>nd</sup> IET Renewable Power Generation Conference (RPG 2013).